

Using a 32-bit motor driver chip and Field-Oriented Control (FOC), the RoboMaster C620 Brushless DC Motor Speed Controller enables precise control over motor torque.



ROBOMASTER

Exclusively designed for the RoboMaster M3508 P18 Brushless DC Gear Motor and C620 Brushless DC Motor Speed Controller, this M3508 Accessories Kit includes servo cables and a terminal board.

Refer to System Specification Manual, RoboMaster System User Manual, Introduction of RoboMaster System Module.

The M3508 Accessories Kit includes servo cables and a terminal board, and is not compatible with other servo cables or terminal boards.

# ROBOMASTER 2019

## ROBOTICS COMPETITION



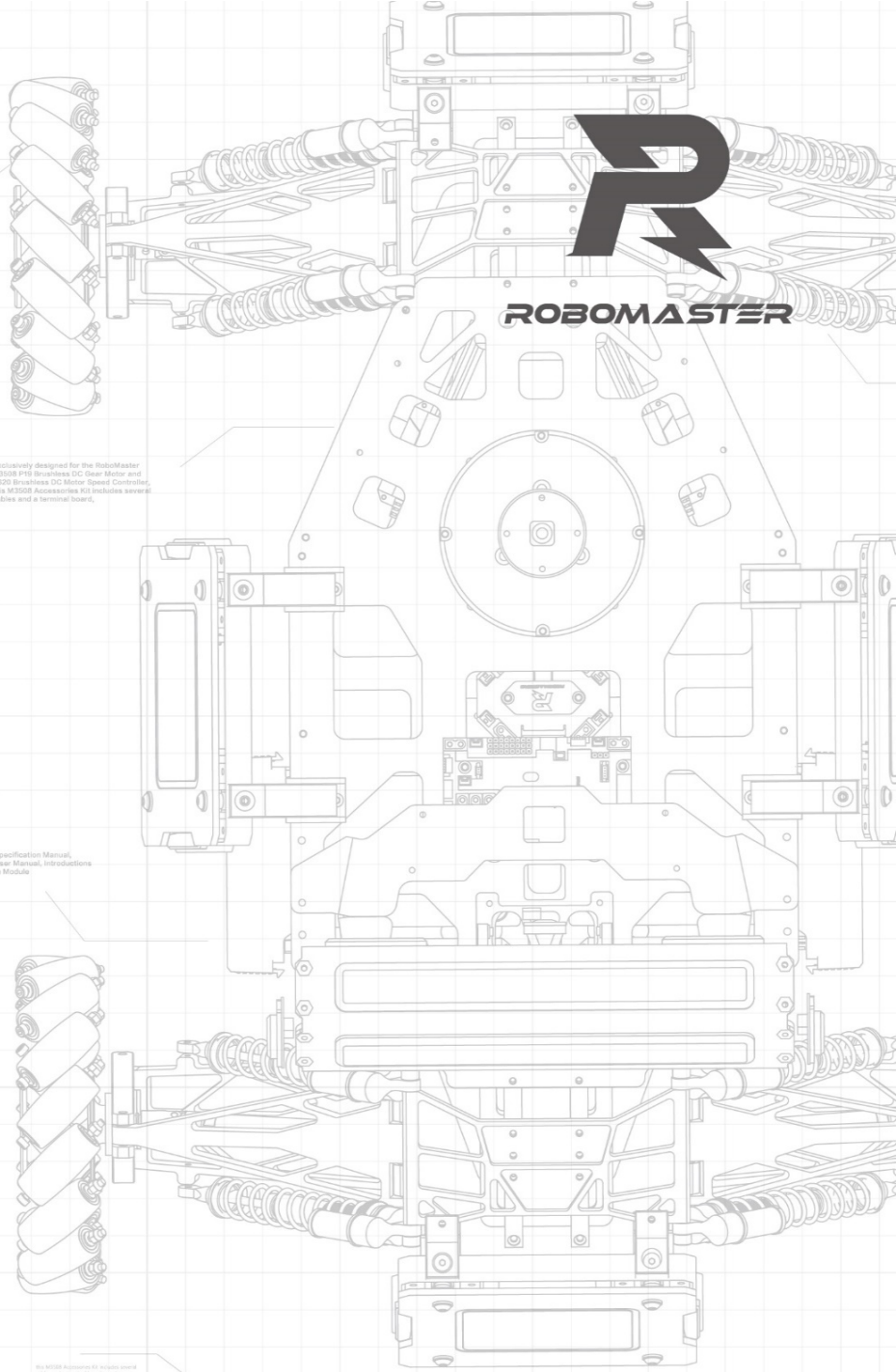
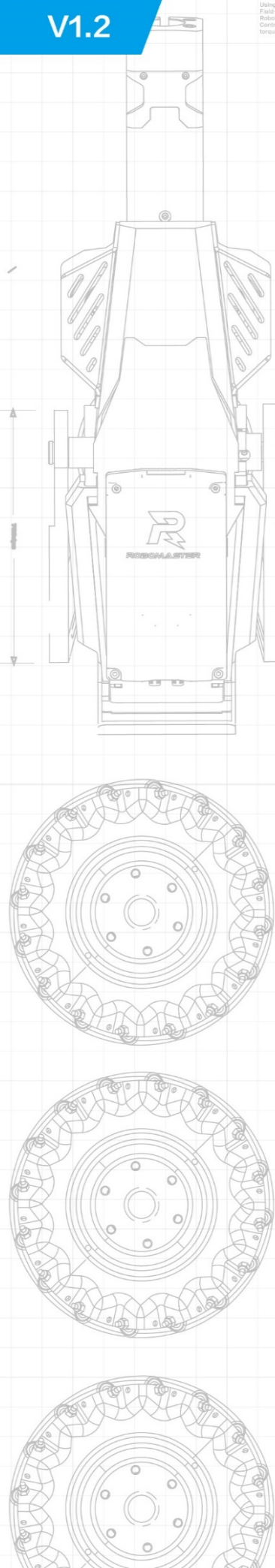
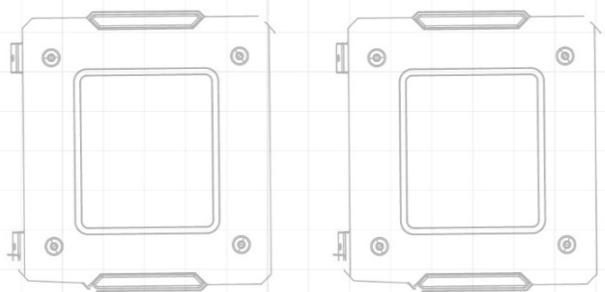

# RULES MANUAL

Prepared by the RoboMaster Organizing Committee  
Updated on April, 2019



# Using This Manual

## Legend

 Prohibition	 Important	 Hits and Tips	 Reference
---	---	---	---

## Release Notes

Date	Version	Changes
2018.09.20	V1.0	Release
2018.11.30	V1.1	<ol style="list-style-type: none"><li>1. Update Competition Area drawings and parameter (including Battlefield, Bridge, Resource Island, Projectile Container, Assistive Column, Power Rune, Landing Pad and Official Projectile Supplier)</li><li>2. Update Hero Barrel Heat and HP Deduction caused by 42 mm Projectile</li><li>3. Update HP Deduction inspected by Base Triangle Armor</li><li>4. Update Energy system of Aerial</li><li>5. Update aesthetic design of robot</li><li>6. Update Pre-match Inspection Form (glossiness limit, flight inspection, weight of the Referee System)</li><li>7. Update awards of the Regional Competition, Aesthetic Design Award, Outstanding Contribution Award and Open Source Prize</li><li>8. Update Types of Team, Requirement for Team, Technical Assessment Specification and Technical Exchange QQ Group.</li></ol>

Date	Version	Changes
2019.5.5	V1.2	<ol style="list-style-type: none"> <li>1. Update Season Schedule (including Final Robot Assessment Video, Referee System Exam, South China Regional Competition, North China Regional Competition, Wild Card Competition, International Regional Competition and Final Tournament) and the Qualification for the Final Tournament.</li> <li>2. Add selection criteria and selection process of Aesthetic Design Award.</li> <li>3. Update post format of Rules Update and Q&amp;A.</li> <li>4. Add qualification for Business Manager.</li> <li>5. Update Sponsor Sepcification.</li> <li>6. Update General Technical Specification (including Power Supply, Gas Source, Remote Controller, Optical Equipment, Robot Numbering, Aesthetic Design and Launching Mechanism).</li> <li>7. Update Robot Technical Specification.</li> <li>8. Update specification and referee weight of each robot.</li> <li>9. Add strength requirement of Standard and update projectile supply requirement.</li> <li>10. Update Aerial Energy mechanism, safety regulations and add module offline mechanism.</li> <li>11. Add pre-match inspection requirement of chassis power of Standard and Hero.</li> <li>12. Update Armor attack inspection mechanism.</li> <li>13. Update Armor Module ID setting specification of participating teams.</li> </ol>

Date	Version	Changes
		<ul style="list-style-type: none"> <li>14. Update HP Recovery and Revival mechanism.</li> <li>15. Update drawings and parameters of Competition Area (including Battlefield, Starting Zone, Sentry Rail, Supplier Zone, Supplier Penalty Zone, Bridge, Road, Projectile Container, Power Rune and Landing Pad). Add drawings and parameters of position relation between Bridge Top Platform and Power Rune, projectile supply area of Projectile Supplier, position relation of Aerial Safety Rope and Battlefield.</li> <li>16. Add projectile supply instruction of Official Projectile Supplier.</li> <li>17. Update RFID card working mechanism of Bridge Top Platform.</li> <li>18. Add instruction, specifications and violations and penalties of Road Penalty Zone.</li> <li>19. Update Projectile Container specifications.</li> <li>20. Add Power Rune rotate direction, rotate mechanism and update the available time and status of Power Rune.</li> <li>21. Add indicator onto the Landing Pad and the working mechanism.</li> <li>22. Update Operator Room specifications.</li> <li>23. Update projectile mass parameters.</li> <li>24. Update participant specifications.</li> <li>25. Update Three-Minute Setup Period specifications.</li> <li>26. Update Team Technical Timeout acquiring chance for participating teams.</li> </ul>

Date	Version	Changes
		<p>27. Update appeal process.</p> <p>28. Update violations and penalties (including participating specification, General Technical Specification, Robot Technical Specification, Aerial safety regulations, Resource Island Penalty Zone, Projectile Container, Operator Room Referee, participant specification, Three-Minute Setup Period, Transformation and Interaction and Rescue and Revival).</p> <p>29. Update Appendix 3 Referee System Exam specification.</p> <p>30. Update Appendix 5 Pre-match Inspection Form (including referee system weight, Aerial safety module, Armor Module, power inspection, Speed Monitor Module, Positioning System Module, gas source, Standard strength, aesthetic design and miscellaneous).</p>

# Contents

Using This Manual .....	2
Legend .....	2
Release Notes .....	2
Competition Background .....	13
<b>1. Introduction.....</b>	<b>14</b>
1.1 Season Schedule .....	14
1.2 Awards .....	18
1.2.1 Final Tournament .....	18
1.2.2 Wild Card Competition .....	19
1.2.3 Regional Competition.....	19
1.2.4 Outstanding Contribution Award .....	20
1.2.5 Aesthetic Design Award .....	22
1.2.6 Open Source Award .....	26
1.3 Intellectual Property Statement.....	27
1.4 Rules Update and Q&A.....	27
<b>2. Team Requirement .....</b>	<b>29</b>
2.1 Requirement for Participant .....	29
2.2 Requirement for Team .....	32
2.3 Team Type .....	34
2.4 Sponsor Specification .....	35
2.4.1 Naming rights .....	36
2.4.2 Participating Team Apparel Advertising Space .....	36
2.4.3 Robot Body Advertising Space .....	36
<b>3. Technical Specification .....</b>	<b>37</b>
3.1 General Technical Specification .....	37
3.2 Robot Technical Specification.....	45
3.2.1 Standard.....	46
3.2.2 Sentry.....	49
3.2.3 Hero .....	53
3.2.4 Aerial .....	55
3.2.5 Engineer.....	60
<b>4. Referee System.....</b>	<b>64</b>
4.1 Overview .....	64
4.2 Level Up .....	65
4.3 HP Deduction .....	66
4.3.1 Barrel Heat.....	66
4.3.2 Chassis Power Consumption.....	68
4.3.3 Armor Attack.....	70
4.3.4 Referee System Going Offline .....	71

4.4	HP Recovery and Revival .....	73
<b>5.</b>	<b>Competition Area.....</b>	<b>74</b>
5.1	Overview .....	74
5.2	Starting Zone.....	75
5.2.1	Base Zone.....	77
5.2.2	Sentry Rail.....	78
5.2.3	Base .....	79
5.3	Supplier Zone .....	80
5.3.1	Restoration Zone .....	81
5.3.2	Projectile Supplier .....	81
5.4	Supplier Penalty Zone .....	83
5.5	Open Zone .....	83
5.5.1	Bridge.....	83
5.5.2	Bunker.....	86
5.5.3	Road.....	86
5.6	Resource Island .....	88
5.6.1	Resource Island Penalty Zone.....	90
5.6.2	Projectile Depot.....	91
5.6.3	Assistive Column .....	94
5.6.4	Assistive Column Penalty Zone .....	95
5.6.5	Power Rune .....	95
5.7	Flight Zone .....	98
5.7.1	Landing Pad.....	98
5.7.2	Aerial Safety Rope .....	100
5.8	Operator Room.....	100
5.8.1	Facility .....	101
5.8.2	Operator .....	101
5.8.3	Operator Room Referee .....	102
5.9	Projectile.....	103
<b>6.</b>	<b>Competition Procedure and Rules .....</b>	<b>104</b>
6.1	General Competition Rundown.....	104
6.2	Criteria Required to Win.....	106
6.2.1	A Single Round .....	106
6.2.2	Rankings for Group Stage .....	106
6.3	Competition Area Personnel .....	107
6.3.1	Specification for Participant .....	107
6.3.2	Duty of Event Staff .....	108
6.4	Pre-match Procedure .....	109
6.4.1	Inspection Specification .....	109
6.4.2	Staging Area Specification.....	110

6.5	Match Procedure .....	111
6.5.1	Penalty Type .....	112
6.5.2	Three-minute Setup Period.....	114
6.5.3	Referee System Initialization Period.....	120
6.5.4	Seven-minute Match Round .....	121
6.5.5	Severe Violation and Cheating .....	127
6.6	Post-Match Procedure .....	128
6.6.1	Results Confirmation.....	128
6.6.2	Appeal .....	129
	Appendix 1 Safety Instruction .....	132
	Appendix 2 Definition of RoboMaster Terminology.....	134
	Appendix 3 Technical Assessment Specification.....	145
	Appendix 4 RM Online Product Education Discount.....	154
	Appendix 5 Pre-match Inspection Form .....	155
	Appendix 6 Reference Drawing .....	163



# Table Directory

Table 1-1 Online Match Schedule .....	15
Table 1-2 Offline Match Schedule .....	17
Table 1-3 Final Tournament Award.....	18
Table 1-4 Wild Card Competition Award .....	19
Table 1-5 Regional Competition Award.....	19
Table 1-6 Outstanding Contribution Award .....	21
Table 1-7 Best Aesthetic Design Award (Individual Award) in the Regional Competition.....	22
Table 1-8 Outstanding Aesthetic Design Award (Team Award) in the Regional Competition.....	22
Table 1-9 Best Aesthetic Design Award (Individual Award) of the Year .....	23
Table 1-10 Outstanding Aesthetic Design Award (Team Award) of the Year .....	23
Table 1-11 Best Aesthetic Design Award Selection Criteria (Single Award) .....	23
Table 1-12 Selection Criteria for Excellent Aesthetic Design Award (Team Award) .....	24
Table 1-13 Robot Makeup Photo Shoot Arrangement .....	25
Table 1-14 Open Source Award .....	26
Table 1-15 Q&A Channel.....	28
Table 2-1 Requirement for Participant.....	29
Table 2-2 Team Type .....	34
Table 2-3 Participating Team Apparel Ads And Suggested Advertising Space.....	36
Table 3-1 General Technical Specification of Robot .....	38
Table 3-2 Robot Entrance Lineup.....	45
Table 3-3 Standard Specification .....	46
Table 3-4 Standard Level Parameter .....	49
Table 3-5 Sentry Specification.....	49
Table 3-6 Hero Specification .....	53
Table 3-7 Hero Level up Parameter .....	55
Table 3-8 Aerial Specification .....	55
Table 3-9 Engineer Specification.....	60
Table 4-1 Referee System Modules .....	64
Table 4-2 Robot Status in the Monitor Process.....	65
Table 4-3 Penalties for Exceeding the Initial Firing Speed Limit.....	66
Table 4-4 Robot Chassis Power Consumption Limit.....	68
Table 4-5 Penalties for Chassis Power Consumption Exceeds the Limit.....	68
Table 4-6 HP Deduction of Armor Attack.....	71
Table 4-7 First Revival Time for Different Types of Robot .....	73
Table 5-1 Aerial Operator Description.....	101
Table 5-2 Projectile Parameters .....	103
Table 6-1 Result and Score of Group Round Robin .....	106
Table 6-2 Criteria Required to Win of Knock-Out Stage .....	106
Table 6-3 Duty of Event Staff.....	108

Table 6-4 Inspection Specification and Violations and Penalties.....	109
Table 6-5 Staging Area Specification and Violations and Penalties .....	111
Table 6-6 Warnings and Penalties That A Referee Executes .....	112
Table 6-7 Specification and Violations and Penalties During the Three-minute Setup Period.....	114
Table 6-8 Malfunctions .....	118
Table 6-9 Team Technical Timeout Specification and Violations and Penalties .....	119
Table 6-10 Projectile Obtaining Specification and Violations and Penalties.....	121
Table 6-11 Transformation and Interaction Specification and Violations and Penalties .....	124
Table 6-12 Rescue and Revival Specification and Violations and Penalties.....	125
Table 6-13 Severe Violation .....	127
Table 6-14 Cheating .....	128
Table 6-15 Rating System .....	145
Table 6-16 Season Schedule Evaluation Requirement .....	146
Table 6-17 Mid-term Robot Assessment Video Evaluation Requirement.....	148
Table 6-18 Technical Proposal Evaluation Requirement .....	149
Table 6-19 Robot Design Evaluation Requirement.....	150
Table 6-20 Final Robot Assessment Video Evaluation Requirement .....	151
Table 6-21 Season Summary Evaluation Requirement.....	153

# Diagram Directory

Figure 3-1 Aerial Energy Mechanism .....	58
Figure 4-1 Client FPV .....	67
Figure 4-2 HP Deduction Logic When the Barrel Heat Exceeds the Limit (left) and Barrel Heat Cooling Logic (right).....	67
Figure 4-3 Chassis Power Consumption Detection and HP Deduction .....	69
Figure 4-4 Chassis Power Consumption Detection and Chassis Powering Off.....	70
Figure 4-5 HP Deduction Mechanism of Referee System Important Module Going Offline .....	71
Figure 4-6 Standard and Hero Armor Module ID Setting.....	72
Figure 5-1 Battlefield Top View.....	74
Figure 5-2 Battlefield Axonometric Drawing.....	75
Figure 5-3 Rubber Reference Drawing.....	75
Figure 5-4 Starting Zone Front View .....	76
Figure 5-5 Starting Zone Top View.....	76
Figure 5-6 Starting Zone Axonometric Drawing.....	77
Figure 5-7 Base .....	77
Figure 5-8 Sentry Rail .....	78
Figure 5-9 Open Base Shield .....	79
Figure 5-10 Close Base Shield .....	80
Figure 5-11 Supplier Zone.....	81
Figure 5-12 Projectile Supplier.....	82
Figure 5-13 Bridge.....	84
Figure 5-14 Bridge Top Platform .....	85
Figure 5-15 Position Relation between the Bridge Top Platform and Power Rune.....	85
Figure 5-16 Bridge End Platform.....	86
Figure 5-17 Bunker.....	86
Figure 5-18 Road.....	87
Figure 5-19 Road Penalty Zone .....	87
Figure 5-20 Resoure Island Top View .....	88
Figure 5-21 Resource Island Front View.....	89
Figure 5-22 Resource Island Axonometric Drawing .....	89
Figure 5-23 Resource Island.....	90
Figure 5-24 Resource Island Penalty Zone .....	90
Figure 5-25 Location of Projectile Containers.....	92
Figure 5-26 Raising Position of Projectile Containers .....	92
Figure 5-27 Projectile Containers on Both Sides of the Resource Island .....	93
Figure 5-28 Projectile Containers in the Central Area of the Resource Island Platform .....	93
Figure 5-29 Resource Island Assistive Column .....	94
Figure 5-30 Assistive Column Penalty Zone .....	95
Figure 5-31 Location of Large Armor Module .....	96

Figure 5-32 Power Rune is Unavailable .....	97
Figure 5-33 Power Rune is Available .....	97
Figure 5-34 Power Rune is Activating .....	98
Figure 5-35 Power Rune is Activated.....	98
Figure 5-36 Landing Pad.....	99
Figure 5-37 Projectile Supply Area of Projectile Supplier .....	99
Figure 5-38 Position Relation between Aerial Safety Rope and Battlefield.....	100
Figure 6-1 Procedure of A Single Match .....	105

## Competition Background

Founded by SZ DJI Technology Co., Ltd. and designed for young engineers, RoboMaster is a global educational robotics program that includes events, campus clubs, and pop-culture spinoffs.

The RoboMaster Robotics Competition is China's first FPV (First-Person View)-shooter-based robotics competition. It requires participants to go beyond their textbooks to develop a diverse fleet of robots. Through a process of independent research and development, students gain invaluable industrial practice and strategic planning skills. This helps to combine their book knowledge with practice in this field. The most advanced and intelligent robots are built through intense competition and relentless improvement.

The RoboMaster Robotics Competition is a global competition that technology enthusiasts from all over the world can enjoy and take part in. With this competition, we hope that robotics and engineering can reach a greater audience and inspire future generations.

RoboMaster attempts to reform the traditional methods of training talent. In the process of developing robotics, participants are provided with a platform where they can interact with like-minded peers, hone and further improve their skills, and advance tirelessly towards their dreams.

All RoboMaster 2019 Robotics Competition participants should abide by the rules and the relevant documents of the competition. Three main entry specification documents are required for the RoboMaster 2019 Robotics Competition. They are RoboMaster 2019 Robotics Competition Rules Manual, RoboMaster 2019 Robotics Competition Participants Manual, and RoboMaster 2019 Robotics Competition Referee System Specification Manual. All documents are subject to the latest version officially released by the RoboMaster Organizing Committee (RMOC).

The competition rules described in the RoboMaster 2019 Robotics Competition Rules Manual should be literally interpreted. Participants are not allowed to speculate and distort the meaning of the words in the manual. The interpretation of the RM2019 competition rules should not be combined with information from previous rules manuals, nor should you refer to any previous competition rules descriptions, core game venue sizes and projectile specifications in the process of designing robots.

# 1. Introduction

The core form of RoboMaster 2019 Robotics Competition is a shootout between robots using semi-automatic projectile launchers. To participate in the competition, teams must design and develop multiple robots that meet the requirements. These robots can be either remotely operated or fully-automated to independently collect projectiles placed in the Competition Area and use them to attack the opposing team's robots. To win the competition, one must destroy the opponent's Base.

Compared with the 2018 Season, the 2019 Season has the following changes:

## A. Robot

- Official Projectile Supplier is officially provided instead of designed by teams
- The capacity of projectiles, the speed of launch, and the frequency of launch of Aerial are no longer restricted, which increase the robot's strategic advantage
- Hero can no longer climb the Resource Island to obtain Projectile Containers
- Engineer is responsible for obtaining Projectile Containers and rescuing robots
- Standard also has new tasks

## B. Battlefield

- Official Projectile Supplier and Base are officially provided core components
- The number of Resource Island drops from two to one
- Power Rune is redesigned
- The road condition of the Open Zone is more complicated

## 1.1 Season Schedule



The following is the RoboMaster 2019 Robotics Season Schedule for reference only. The specific time is subject to the latest announcement by the RMOC.

---

There are three types of team: teams from Mainland China, teams from Hong Kong, Macau, Taiwan and Overseas and Chinese and Foreign Joint Teams. The property and entry procedure of Chinese and Foreign Joint Teams depend on the college's location.

Teams must complete the Technical Assessment task of corresponding stage before qualifying for further Assessment, Warm-up Competition, Regional Competition, International Regional Competition, Wild Card Competition and Final Tournament. Only outstanding teams of Regional Competition, International Regional Competition or Wild Card Competition qualify for the Final Tournament.

Teams passing the Technical Assessment can gain the corresponding number of RM Online Product Education Discount (hereinafter referred to as "Product Discount") provided by the RMOC. For details about technical assessment specifications, please refer to [Appendix 3 Technical Assessment](#)

[Specification](#). For online product of each type of robot, please refer to [Appendix 4 RM Online Product Education Discount](#).

It is recommended that each team drafts out a 2019 Season Schedule to evaluate its personnel and funding needs. Teams are also advised to stick to a budget when making their robots at the beginning of the preparation stage.

RM2019 Season Schedule consists of online match schedule and offline match schedule.

Table 1-1 Online Match Schedule

Schedule (Beijing Time)	Item	Property	Rights and Duties
<b>September 20 – October 31, 2018</b>	Registration on Official Website	Required for teams from Mainland China	Log in the <a href="#">RoboMaster website</a> and complete the registration as required
<b>September 20 – November 16, 2018</b>		Required for teams from Hong Kong, Macau, Taiwan and Overseas	
<b>10:00-22:00, October 22, 2018</b>	Technical Assessment -- The first round of Rules Exam (Chinese)	<ul style="list-style-type: none"> <li>Required for all teams</li> <li>Teams that have passed the first round of Rules Exam cannot take the second round</li> </ul>	<ul style="list-style-type: none"> <li>Receive one set of product discount coupon for Aerial and one set for Standard.</li> <li>Teams that gain 100 points in the first round of Rules Exam will receive one GM6020 motor.</li> <li>The first ten teams that gain 100 points in the second round of Rules Exam will receive one GM6020 motor each.</li> <li>Qualify for submitting the Season Schedule.</li> </ul>
<b>10:00-22:00, November 20, 2018</b>	Technical Assessment -- The second round of Rules Exam (Chinese and English)		
<b>October 22 – November 30, 2018</b>		Required for teams from Mainland China	<ul style="list-style-type: none"> <li>Receive one set of product discount coupon for Hero, one for Engineer and one for Sentry.</li> </ul>

Schedule (Beijing Time)	Item	Property	Rights and Duties
<b>October 22 – December 25, 2018</b>	Technical Assessment – Season Schedule	Required for teams from Hong Kong, Macau, Taiwan and Overseas	<ul style="list-style-type: none"> <li>● Qualify for submitting the Mid-term Robot Assessment Video.</li> <li>● Make the Season Schedule open source and the top five open source teams will receive a set of the Standard referee system of the RM2018 version (VTM not included).</li> </ul>
<b>December 25, 2018 – January 23, 2019</b>	Technical Assessment – Mid-term Robot Assessment Video + BOM form	Required for teams from Mainland China	<ul style="list-style-type: none"> <li>● Receive two sets of product discount coupon for Standard and seven 20% off discount coupons for Manifold 2 (EMMC).</li> <li>● The top ten teams will receive one set of the Standard referee system of the RM2018 version (VTM included).</li> <li>● The top 48 teams are allowed to borrow a set of the Standard referee system of the RM2019 version in advance.</li> <li>● The top 80% teams will qualify for submitting their technical proposal.</li> </ul>
<b>January 23 – March 1, 2019</b>		Required for teams from Hong Kong, Macau, Taiwan and Overseas	
<b>December 25, 2018 – February 22, 2019</b>	Technical Assessment –	Required for teams from Mainland China	<ul style="list-style-type: none"> <li>● Qualify for submitting the Final Robot Assessment Video</li> <li>● Make the technical proposal open source and the top five open source teams will receive a set of the Standard referee system of the RM2018 version (VTM not included).</li> </ul>
<b>January 23 – April 1, 2019</b>	Technical Proposal	Required for teams from Hong Kong, Macau, Taiwan and Overseas	



Schedule (Beijing Time)	Item	Property	Rights and Duties
January 23 – April 1, 2019	Technical Assessment –	Required for teams from Mainland China	Qualify for the Referee System Exam
March 1 – May 20, 2019	Final Robot Assessment Video	Required for teams from Hong Kong, Macau, Taiwan and Overseas	
January 23 – April 2, 2019	Technical Assessment –	Required for teams from Mainland China	Qualify for borrowing the full set of Referee System and participating in the Chinese Regional Competition.
March 1 – May 26, 2019	Referee System Exam	Required for teams from Hong Kong, Macau, Taiwan and Overseas	
May - September 2019	Team's Season Summary	Optional	-
The whole season	Open source report	Optional	Eligible to run for the selection of the Open Source Award.

Table 1-2 Offline Match Schedule

Schedule (Beijing Time)	Item	Property	Rights and Duties
May 13 – May 19, 2019	South China Regional Competition	Teams from Mainland China	Teams from Mainland China are free to choose the division or accept the arrangements made by the RMO. The priority in choosing the division is based on the score of Technical Assessment.
May 21 – May 26, 2019	Central China Regional Competition		
May 28 – June 2, 2019	North China Regional Competition		
July 27 – July 30, 2019	Wild Card Competition	Teams from Mainland China	Teams that rank the second place of the Regional Competition qualify for the Wild Card Competition.

Schedule (Beijing Time)	Item	Property	Rights and Duties
<b>August 1 – August 4, 2019</b>	International Regional Competition	Teams from Hong Kong, Macau, Taiwan and Overseas	Teams that pass the Referee System Exam qualify for the International Regional Competition.
<b>August 3 – August 11, 2019</b>	Final Tournament	Teams from Mainland China; Teams from Hong Kong, Macau, Taiwan and Overseas	Teams that win the grand prize and first prize of the Chinese Regional Competition or International Regional and teams that advance to the Wild Card Competition qualify for the Final Tournament.

 Promotion Quota: The organizing committee will determine the quota to be promoted to the Wild Card Competition and Final Tournament in each divisional competition, according to a certain proportion as well as the total number of teams and the number of seed teams in each division.

## 1.2 Awards

### 1.2.1 Final Tournament

Awards of the Final Tournament are as follows:

Table 1-3 Final Tournament Award

Prize	Ranking	Qty.	Reward
<b>Grand Prize</b>	Champion	1	<ul style="list-style-type: none"> <li>● Champion Trophy</li> <li>● Champion Medal</li> <li>● Grand Prize Certificate</li> <li>● Cash prize of USD \$ 75,000 (before tax)</li> </ul>
	First Runner-up	1	<ul style="list-style-type: none"> <li>● First Runner-up Trophy</li> <li>● First Runner-up Medal</li> <li>● Grand Prize Certificate</li> <li>● Cash prize of USD \$ 45,000 (before tax)</li> </ul>
	Second Runner-up	1	<ul style="list-style-type: none"> <li>● Second Runner-up Trophy</li> <li>● Second Runner-up Medal</li> <li>● Grand Prize Certificate</li> <li>● Cash prize of USD \$ 15,000 (before tax)</li> </ul>

Prize	Ranking	Qty.	Reward
	Fourth	1	<ul style="list-style-type: none"> <li>● Grand Prize Certificate</li> <li>● Cash prize of USD \$ 15,000 (before tax)</li> </ul>
<b>First Prize</b>	Fifth to Eighth	4	<ul style="list-style-type: none"> <li>● First Prize Certificate</li> <li>● Cash prize of USD \$ 7,500 (before tax)</li> </ul>
	Ninth to 16th	8	<ul style="list-style-type: none"> <li>● First Prize Certificate</li> <li>● Cash prize of USD \$ 4,500 (before tax)</li> </ul>
<b>Second Prize</b>	17th to 32nd	16	Second Prize Certificate



The name of the award will be changed later and is subject to the actual certificate issued.

## 1.2.2 Wild Card Competition

Awards of the Wild Card Competition are as follows:

Table 1-4 Wild Card Competition Award

Prize	Ranking	Qty.	Reward
<b>Third Prize</b>	Teams that did not advance to the Final Tournament	Multiple	Third Prize Certificate

## 1.2.3 Regional Competition

Awards of the Regional Competition are as follows:

Table 1-5 Regional Competition Award

Prize	Ranking	Qty.	Reward
<b>Regional Grand Prize</b>	Regional Champion	1/region	<ul style="list-style-type: none"> <li>● Champion Trophy</li> <li>● Regional Grand Prize Certificate</li> <li>● Cash prize of USD \$ 4,500 (before tax)</li> </ul>
	Regional First Runner-up	1/region	<ul style="list-style-type: none"> <li>● First Runner-up Trophy</li> <li>● Regional Grand Prize Certificate</li> </ul>

Prize	Ranking	Qty.	Reward
			<ul style="list-style-type: none"> <li>● Cash prize of USD \$ 4,500 (before tax)</li> </ul>
	Regional Second Runner-up	1/region	<ul style="list-style-type: none"> <li>● Second Runner-up Trophy</li> <li>● Regional Grand Prize Certificate</li> <li>● Cash prize of USD \$ 4,500 (before tax)</li> </ul>
	Regional Fourth	1/region	<ul style="list-style-type: none"> <li>● Regional Grand Prize Certificate</li> <li>● Cash prize of USD \$ 4,500 (before tax)</li> </ul>
<b>Regional First Prize</b>	Based on the region's allocated quota, top ranking teams in each region qualify for the Final Tournament	12 in total from four regions	<ul style="list-style-type: none"> <li>● Regional Grand Prize Certificate</li> <li>● Cash prize of USD \$ 4,500 (before tax)</li> </ul>
<b>Regional Second Prize</b>	In addition to the teams that directly advance to the Final Tournament, other top-ranking teams in each region may advance to based on each region's allocated quota.	Multiple	Regional Second Prize Certificate
<b>Regional Third Prize</b>	Teams that did not win first and second prize in the Regional Competition	Multiples	Regional Third Prize Certificate



The International Regional Competition is one kind of the Regional Competition.

## 1.2.4 Outstanding Contribution Award

Outstanding Contribution Award is as follows:

Table 1-6 Outstanding Contribution Award

Prize	Ranking	Qty.	Reward
<b>Outstanding Supervisor</b>	Outstanding Supervisor of the Year	6	<ul style="list-style-type: none"> <li>● Honor certificate</li> <li>● USD \$ 1,500 (pre-tax)</li> </ul>
	Outstanding Supervisor in the Regional Competition	6	<ul style="list-style-type: none"> <li>● Honor certificate</li> <li>● USD \$ 750 (pre-tax)</li> </ul>
<b>Outstanding Captain</b>	Outstanding Captain of the Year	4	<ul style="list-style-type: none"> <li>● Honor certificate</li> <li>● USD \$ 750 (pre-tax)</li> </ul>
	Outstanding Captain in the Regional Competition	4	<ul style="list-style-type: none"> <li>● Honor certificate</li> <li>● USD \$ 300 (pre-tax)</li> </ul>
<b>Outstanding Project Manager</b>	Outstanding Project Manager of the Year	4	<ul style="list-style-type: none"> <li>● Honor certificate</li> <li>● USD \$ 750 (pre-tax)</li> </ul>
	Outstanding Project Manager in the Regional Competition	4	<ul style="list-style-type: none"> <li>● Honor certificate</li> <li>● USD \$ 300 (pre-tax)</li> </ul>
<b>Outstanding PR Manager</b>	Outstanding PR Manager of the Year	4	<ul style="list-style-type: none"> <li>● Honor certificate</li> <li>● USD \$ 450 (pre-tax)</li> </ul>
	Outstanding PR Manager in the Regional Competition	4	<ul style="list-style-type: none"> <li>● Honor certificate</li> <li>● USD \$ 150 (pre-tax)</li> </ul>
<b>Outstanding Business Manager</b>	Outstanding Business Manager of the Year	4	<ul style="list-style-type: none"> <li>● Honor certificate</li> <li>● USD \$ 450 (pre-tax)</li> </ul>
	Outstanding Business Manager in the Regional Competition	4	<ul style="list-style-type: none"> <li>● Honor certificate</li> <li>● USD \$ 150 (pre-tax)</li> </ul>
<b>Outstanding Advisor</b>	Outstanding Advisor of the Year	4	<ul style="list-style-type: none"> <li>● Honor certificate</li> <li>● USD \$ 450 (pre-tax)</li> </ul>
	Outstanding Advisor in the Regional Competition	4	<ul style="list-style-type: none"> <li>● Honor certificate</li> <li>● USD \$ 150 (pre-tax)</li> </ul>
<b>Outstanding Volunteer</b>	Outstanding Volunteer of the Year	10	Honor certificate
	Outstanding Volunteer in the Regional Competition	10	Honor certificate

Prize	Ranking	Qty.	Reward
<b>Creativity Award</b>	-	4	Honor certificate

## 1.2.5 Aesthetic Design Award

In order to improve the identity and aesthetics of the robot's appearance, the organizing committee encourages teams to add industrial design elements when designing the robot protective case. The organizing committee will award teams with aesthetically pleasing robots.

### 1.2.5.1 Award Items

The Aesthetic Design Award includes the Best Aesthetic Design Award (i.e. Individual Award) and the Outstanding Aesthetic Design Award (i.e. Team Award). The Best Aesthetic Design Award will select the most aesthetically pleasing robots in each unit and the Outstanding Aesthetic Design Award will select the top ten teams that make the most beautiful and exquisite robots.

Aesthetic Design in the Regional Competition will be determined by the RMOC before the start of the Regional Competition.

Table 1-7 Best Aesthetic Design Award (Individual Award) in the Regional Competition

Robot	Qty.	Reward
<b>Standard</b>	1/region	<ul style="list-style-type: none"> <li>● Honor certificate</li> <li>● USD \$ 450 (before tax)</li> </ul>
<b>Engineer</b>	1/region	<ul style="list-style-type: none"> <li>● Honor certificate</li> <li>● USD \$ 450 (before tax)</li> </ul>
<b>Hero</b>	1/region	<ul style="list-style-type: none"> <li>● Honor certificate</li> <li>● USD \$ 450 (before tax)</li> </ul>
<b>Aerial</b>	1/region	<ul style="list-style-type: none"> <li>● Honor certificate</li> <li>● USD \$ 450 (before tax)</li> </ul>
<b>Sentry</b>	1/region	<ul style="list-style-type: none"> <li>● Honor certificate</li> <li>● USD \$ 450 (before tax)</li> </ul>

Table 1-8 Outstanding Aesthetic Design Award (Team Award) in the Regional Competition

Robot	Qty.	Reward
<b>All</b>	10/region	A 2-minute Team Technical Timeout (only valid in the Regional Competition)

Aesthetic Design in the Regional Competition will be determined by the RMOC before the start of the Final Tournament.

Table 1-9 Best Aesthetic Design Award (Individual Award) of the Year

Robot	Qty.	Reward
Standard	1	<ul style="list-style-type: none"> <li>● Honor certificate</li> <li>● USD \$ 750 (before tax)</li> </ul>
Engineer	1	<ul style="list-style-type: none"> <li>● Honor certificate</li> <li>● USD \$ 750 (before tax)</li> </ul>
Hero	1	<ul style="list-style-type: none"> <li>● Honor certificate</li> <li>● USD \$ 750 (before tax)</li> </ul>
Aerial	1	<ul style="list-style-type: none"> <li>● Honor certificate</li> <li>● USD \$ 750 (before tax)</li> </ul>
Sentry	1	<ul style="list-style-type: none"> <li>● Honor certificate</li> <li>● USD \$ 750 (before tax)</li> </ul>

Table 1-10 Outstanding Aesthetic Design Award (Team Award) of the Year

Robot	Qty.	Reward
All	10	A 2-minute Team Technical Timeout (only valid in the Final Tournament)

### 1.2.5.2 Selection Criteria

The selection criteria for the Regional Competition and the Annual Best Aesthetic Design Award (Single Award) are as follows:

Table 1-11 Best Aesthetic Design Award Selection Criteria (Single Award)

Scoring	Weight	Description of Criteria		
		4-5	2-3	1
Degree of Completion	30%	Serious attitude in line with the rules, regular and orderly components, strong sense of style in shell, rich decorative details	Serious attitude, in line with the rules, with a decorative shell	Attitude is not serious or does not meet the requirements of the rules
Degree of Aesthetic Beauty	30%	Beautiful overall, with a reproducible design language	Overall, somewhat beautiful	Unsightly

Scoring	Weight	Description of Criteria		
		4-5	2-3	1
<b>Degree of Inimitability</b>	20%	The appearance is very characteristic, easily remembered and recognizable at a glance	The appearance has characteristics that can be remembered and recognized	The appearance is not characteristic and is difficult to remember
<b>Degree of Innovation</b>	20%	New materials, new processes, new shapes, novel design languages, etc., with excellent results	Try to adopt new materials, new processes, new shapes, novel design languages, etc.	Step by step, no innovation

The selection criteria for the Regional Competition and the Annual Excellent Aesthetic Design Award (Team Award) are as follows:

Table 1-12 Selection Criteria for Excellent Aesthetic Design Award (Team Award)

Scoring	Weight	Description of Criteria		
		4-5	2-3	1
<b>Degree of Completion</b>	30%	The team's robots have a serious attitude, in line with the rules, as well as an attractive design, regular and orderly components, strong sense of style in shell, and rich decorative details.	Serious attitude, in line with the rules, and most robots have a design with an attractive appearance	Attitude is not serious, does not meet the rules, or only individual robots have an attractive design
<b>Degree of Aesthetic Beauty</b>	20%	The whole team demonstrates an overall beauty with a reproducible design language	Overall beautiful exists somewhat for the whole team	Unsightly



Scoring	Weight	Description of Criteria		
		4-5	2-3	1
Degree of Inimitability	20%	The appearance is very characteristic for the whole team, easily remembered, and recognized at a glance	The appearance of the whole team has characteristics that can be remembered and recognized	The appearance is not characteristic and is difficult to remember
Degree of Coordination	20%	The color, material, style and design language of the team's robots are coordinated and the sense of unity is strong.	The team's robots are somewhat coordinated in appearance, uniform in style, and have a certain sense of unity.	The style is not uniform
Degree of Innovation	10%	New materials, new processes, new shapes, novel design languages, etc., with excellent results	Try to adopt new materials, new processes, new shapes, novel design languages, etc.	Step by step, no innovation



The selection criteria for the annual aesthetic design award are related to firmness. For subsequent adjustments, please pay attention to the latest announcements issued by the organizing committee.

### 1.2.5.3 Selection Process

If the participating teams need to participate in the aesthetic design award selection, the following processes should be followed:

1. Participating team members shall create an “我行 3DE 平台” account. A team can create an unlimited number of accounts and teams with 12 registered accounts qualify for the aesthetic design award selection.



Overseas teams do not need to register for a platform account, but can directly participate in the aesthetic design awards selection.

2. The robot shall be photographed with makeup and the shooting date is as follows:

Table 1-13 Robot Makeup Photo Shoot Arrangement

Date	Competition	Participating Teams
May 14, 2019	Southern Regional Competition	Mainland teams

Date	Competition	Participating Teams
May 21, 2019	Middle Regional Competition	
May 28, 2019	Northern Regional Competition	
August 2, 2019	International qualifiers	Teams from Hong Kong, Macau, Taiwan and Overseas
August 3 - 4, 2019	Finals	Mainland teams and teams from Hong Kong, Macau, Taiwan and Overseas

3. At the time of the annual aesthetic design award, at least one person in each team must explain the design concept in the preparation area.

## 1.2.6 Open Source Award

Open Source Award is as follows:

Table 1-14 Open Source Award

Prize	Qty.	Reward	Notes
Open Source Grand Prize	Multiple	<ul style="list-style-type: none"> <li>Honor certificate</li> <li>USD \$ 15,000 (pre-tax)</li> </ul>	<p>In the RM 2019 Season (September 20, 2018 to August 31, 2019), teams share their core technology or operation management methods in the RoboMaster Forum and the official website, promoting the development of the RoboMaster Robotics Competition and the engineering culture and spirit.</p>
Open Source First Prize	Multiple	<ul style="list-style-type: none"> <li>Honor certificate</li> <li>USD \$ 7,500 (pre-tax)</li> </ul>	
Open Source Second Prize	Multiple	<ul style="list-style-type: none"> <li>Honor certificate</li> <li>USD \$ 4,500 (pre-tax)</li> </ul>	
Open Source Third Prize	Multiple	<ul style="list-style-type: none"> <li>Honor certificate</li> <li>USD \$ 1,500 (pre-tax)</li> </ul>	
Open Source Outstanding Prize	Multiple	<ul style="list-style-type: none"> <li>Honor certificate</li> <li>Class A: USD \$ 750 (before tax)</li> <li>Class B: USD \$ 450 (before tax)</li> <li>Class C: USD \$ 300 (before tax)</li> </ul>	

## 1.3 Intellectual Property Statement



If there are any violations to the intellectual property rights of the competition and education products provided by the RMOC and the Organizer DJI, the party which owns the rights will pursue compensation according to the law.

The RMOC encourages and advocates technological innovation and open source technology and respects the intellectual property of the teams. All rights related to the intellectual property developed during the competition will be owned by the team. The RMOC will not participate in the process of handling intellectual property disputes among team members. The participating teams must properly handle all aspects of intellectual property rights among school members, company members and other members of the team.

While using the RoboMaster Referee System and other supporting materials provided by the RMOC, teams should respect the ownership of intellectual property. Teams are also prohibited from engaging in any behavior that violates intellectual property rights, including but not limited to reverse engineering, replication or translation.

## 1.4 Rules Update and Q&A

Based on the actual situation of the preparation and competition stage in the RM 2019 Season, RoboMaster 2019 Robotics Competition rules of the following aspects may be updated:

- Minor adjustments to balancing parameters (projectile capacity, power restriction, etc.)
- Modifications to the rules that participants can gain advantages through non-technical means
- Additional penalties or amendments to actions that lead to an unbalanced competition

To ensure a fair and just competition, the timeliness of rules update, and the healthy running of the competition, the RMOC will issue the Rules Hotfix Announcement (hereinafter referred to as "the Announcement") to explain and update rules, which is usually presented in two ways, one is to continue to use the latest version of the Rules Manual and replace the specific texts with modifications and updates; the other is to directly add new rules, regulations, and penalties.

The Announcement reserves a higher right of interpretation over the latest version of the Rules Manual. Rules and regulations that are not mentioned in the Announcement are subject to the latest version of the Rules Manual. Changes of the Announcement will be updated in the Rules Manual and later revoked. The Rules Manual will have a higher version number. All updates of the Rules Manual will be posted on the Events section of the [RoboMaster official forum](#), with the latest version number pinned to the top.

The RMOC provides many Q&A channels as shown below:

Table 1-15 Q&A Channel

Channel	Notes
<b>Official Forum</b>	<p>Questions about the competition rules can be posted on the Events section and about products can be posted on the Products section. The RMOC will reply to it within 2-5 working days.</p> <p>Post title should concentrate on the main points and be clear and concise. The title format is not required.</p> <p>Each week, posts related to rules and rules Q&amp;A will be summarized in the same post, which is synchronized in the FAQ sub-section of the Competition section of the RoboMaster official forum.</p>
<b>Telephone</b>	0755-36383255
<b>Official E-mail</b>	robomaster@dji.com
<b>Competition QQ Group</b>	RoboMaster 2019 Robotics Competition Official Entry QQ Group: 791094259
<b>Competition Enquiry Account</b>	<p>QQ: 2355418059</p> <hr/> <p> Official notices and enquiry related to the competition are subject to the information and answers published via the official QQ number.</p>
<b>WeChat</b>	Account: rmsaiwu
<b>WeChat Group</b>	Add the WeChat account (rmsaiwu) and apply to join the corresponding group (the official competition WeChat group, PR Manager WeChat group, and Supervisor exchange group)

## 2. Team Requirement

### 2.1 Requirement for Participant

The RoboMaster Robotics Competition advocates teamwork spirit. To encourage team members to play important roles, the RMOC will reward those who contribute the most throughout the competition with rewards like Outstanding Captain, Outstanding Supervisor, etc. Below shows the requirement for participants.

Table 2-1 Requirement for Participant

Participant	Role	Number	Qualification	Duties
<b>Supervisor</b>	<ul style="list-style-type: none"> <li>● Head of the team, responsible for team building and management</li> <li>● Cannot serve as Operator, OPM, PR Manager, or Advisor at the same time</li> </ul>	1-5	Faculties of the team's college or university who are qualified for teaching and scientific research.	<ul style="list-style-type: none"> <li>● Responsible for the safety of team members and their properties, guidance and management of the use of funds</li> <li>● Instruct the team to develop project plan and solve R&amp;D issues, helping the team to complete the competition successfully</li> <li>● Actively cooperate with the RMOC and push Captain and OPM to regularly report project progress to the RMOC</li> </ul>

Participant	Role	Number	Qualification	Duties
<b>Advisor</b>	<ul style="list-style-type: none"> <li>● Provide strategic, technical and management support and guidance to the team</li> <li>● Cannot serve as Supervisor, Captain, Operator, OPM, or PR Manager at the same time</li> </ul>	0-5	Full-time junior college students, undergraduates, postgraduates, and doctoral students in colleges and universities, as well as engineers, researchers and faculties working in enterprises, research institutions, or freelancers	Advisor can undertake tasks of manufacturing robots and other competition affairs
<b>Captain (one person only)</b>	<ul style="list-style-type: none"> <li>● Key member of the team, responsible for technology and tactics</li> <li>● The major liaison for the RMOC</li> <li>● Can serve as Operator but cannot serve as OPM, PR Manager or Advisor at the same time</li> </ul>	The overall number of Captain, PR Manager, OPM and Team Member is 5-35	Full-time junior college students, undergraduates, postgraduates, and doctoral students in colleges and universities before August 2019	<ul style="list-style-type: none"> <li>● Responsible for division of labor, overall planning and tactics arrangement and adjustment</li> <li>● Attend Captains Meeting, represent the team to confirm match results and participate in appeal processes and any subsequent hearings</li> <li>● Responsible for the heritage and development of the team after the competition</li> </ul>

Participant	Role	Number	Qualification	Duties
<b>Public Relations (PR) Manager (one person only)</b>	Responsible for promotion			<ul style="list-style-type: none"> <li>● Responsible for pooling promotion resources and establishing a comprehensive system</li> <li>● Plan and organize activities via multiple platforms to increase the influence of the team and RM competition</li> </ul>
<b>Organizational Project Management (OPM) (one person only)</b>	Oversees the entire project			<ul style="list-style-type: none"> <li>● Oversees the entire project</li> <li>● Comprehensively considers R&amp;D costs, work safety and other issues</li> <li>● Plays a decisive role in the project's general objective (e.g. progress, outcome, costs, etc.)</li> </ul>
<b>Team Member</b>	Divided into Technical Group, Operation Group and Operator Group			<ul style="list-style-type: none"> <li>● Technical Group: responsible for R&amp;D work such as robot design and manufacturing and has technical directions such as machine, electronic control and vision. It is recommended that the group has an industrial designer who is in charge of the aesthetic design of robots</li> </ul>

Participant	Role	Number	Qualification	Duties
				<ul style="list-style-type: none"> <li>● Operation Group: responsible for promoting, organizing and planning the competition. It is recommended that the group has a team member who is in charge of attracting investment.</li> <li>● Operator Group: responsible for controlling robots during the competition</li> </ul>
<b>Business Manager</b>	PR Manager and OPM can be concurrently appointed as Business Manager	0-1	Full-time junior college students, undergraduates, postgraduates, and doctoral students in colleges and universities before August 2019	<ul style="list-style-type: none"> <li>● Responsible for pooling internal and external resources</li> <li>● Write and revise investment plans, and seek cooperation through various channels</li> <li>● Provide technical support and funding for the team</li> </ul>

## 2.2 Requirement for Team

Teams must following specifications as shown below:

1. The team must cooperate with a college or university and meet the requirements of role, number and qualification stated in [Table 2-1](#).
2. In principle, only one team per school is eligible to participate in the competition. Institutions that have multiple campuses in different cities, which makes it difficult for students to compete as a team, are allowed to have more than one team once verified by the Committee. Teams must obtain the



entry authorization from their school and submit the proof to the registration system. For the entry authorization template, please refer to the registration system. For a team, the precondition to register for the competition is to obtain the stamped authorization from the college (or campus) it represents. Applicants must ensure that their registration information is complete and accurate, and will undertake the corresponding responsibilities. They must bear all consequences caused by missing any information or providing incorrect registration information. For special circumstances, applicants can contact the Committee to deal with the issue. The Committee reserves the right of final interpretation.

3. The team comes up with their own name, which must be in the format of "XXX-Team" ("- " is only a separator, not in the actual team name) and the total length should not exceed 16 English characters or 8 Chinese characters. The team name cannot consist of the college name or its abbreviation in Chinese or English, or such Chinese characters as "队", "团队" and "战队" which mean "team" in English, or special symbols like "\*/-+". The team name must reflect the positive and pioneering spirit of the team and comply with relevant state laws and regulations.
4. Two or more schools that do not have their own teams to register for the competition can form an intercollegiate team.
  - A. Before the establishment of an intercollegiate team, members must fully communicate with each other based on the actual situation. The team itself must deal with issues of operating and R&D costs, staffing or disputes that may hence arise. RMOC assumes no responsibility for any of these issues.
  - B. Once established, the intercollegiate team shall not dissolve and may only participate in the RoboMaster 2019 Robotics Competition as that team. If the intercollegiate team that has passed the review of technical report dissolves, it shall be deemed as r its qualification for the competition.
  - C. The team name of an intercollegiate team should be "XXX Intercollegiate Team" instead of "XXX Team." It must also submit a statement provided by the team's school to the registration system. For the template of the intercollegiate team statement, please refer to the registration system.
5. Any team member (including Supervisor, Advisor, Captain, PR Manager, OPM and Team Members) may only participate in one team during the 2019 Season.

#### Violations and Penalties:

- If Item 1-4 have not been met, the RMOC will reject the application.
- If Item 5 has not been met, the violator and each team that he/she is part of is regarded as cheating once confirmed by the Chief Referee and the violator will be disqualified from the competition.

## 2.3 Team Type

Below shows the definition, rights and entry procedures for each type of team.

Table 2-2 Team Type

Teams from Mainland China	
<b>Definition</b>	Come from colleges in mainland China, pass the registration review and technical review within the specified time and meet the competition requirements.
<b>Rights</b>	Eligible for the competition and subsequent rounds. Qualify for awards as set out in Award Rules.
<b>Entry Procedures</b>	<ol style="list-style-type: none"> <li>Implement the competition process in accordance with standards for teams from mainland China.</li> </ol> <hr/> <div style="display: flex; align-items: center;">  <p>Event procedure includes policies of material granting, purchasing, and supporting services.</p> </div> <hr/> <ol style="list-style-type: none"> <li>Participate in the (Chinese) Regional Competition and outstanding performers qualify for the Wild Card Competition and the Final Tournament.</li> </ol>
Teams from Hong Kong, Macau, Taiwan and Overseas	
<b>Definition</b>	Come from Hong Kong, Macau, Taiwan and Overseas, invited by the Committee to participate in the competition, pass the registration review and technical review within the specified time and meet the competition requirements.
<b>Rights</b>	<ul style="list-style-type: none"> <li>Eligible for the competition and subsequent rounds. Qualify for awards as set out in Award Rules.</li> <li>Due to different education systems, education background of teams from Hong Kong, Macau, Taiwan and Overseas will not be restricted.</li> </ul>
<b>Entry Procedures</b>	<ol style="list-style-type: none"> <li>Implement the competition process in accordance with standards for teams from Hong Kong, Macau, Taiwan and Overseas.</li> <li>Participate in the International Regional Competition and outstanding performers qualify for the Wild Card Competition and the Final Tournament.</li> </ol>
Chinese and Foreign Joint Teams	
<b>Definition</b>	Come from Chinese-foreign cooperatively-run colleges, pass the registration review and technical review within the specified time and meet the competition requirements.

<b>Rights</b>	Eligible for the competition and subsequent rounds. Qualify for awards as set out in Award Rules.
<b>Entry Procedures</b>	<ol style="list-style-type: none"> <li>1. If the college is located in Mainland China, its team is subject to standards for teams from Mainland China. If the college is located in Hong Kong, Macau, Taiwan or overseas, its team is subject to standards for teams from Hong Kong, Macau, Taiwan and overseas.</li> <li>2. In the RoboMaster 2019 Season, teams are free to choose to follow the entry procedures for Mainland China or the other. The entry procedure shall not be changed throughout the season once confirmed with the staff of the RMOC in the registration period.</li> </ol>

## 2.4 Sponsor Specification

In order to obtain financial, material, and other assistance, teams are encouraged by the RMOC to seek sponsorships independently. In the process of looking for sponsors, in order to protect the interests of each team and maintain the overall brand image of the competition, teams need to follow the investment guideline provided by the RMOC as shown below.

- The investment guideline is only subject to supporting services and sponsorship support of the teams, and does not involve the return and benefits related to the RoboMaster competition.
- Teams must follow the investment process to declare the rights of both parties to the RMOC for approval. Such "sponsorship" include ads placed on the robot body, title sponsors' appearances on the competition spectator system, etc. If the aforementioned process is not followed, the RMOC has the right not to cooperate in the implementation of relevant rights and interests of the competition. The logos of sponsors that fail to pass the declaration approval process cannot be revealed in the competition. This includes but is not limited to: A robot that displays undeclared sponsor information cannot pass the check, the team uniforms that display undeclared sponsor information cannot be revealed in the live broadcast, and the undeclared named sponsor cannot enjoy naming rights etc.
- The RMOC is only responsible to confirm whether the sponsors are acceptable partners and to decide whether to assist the team in implementing rights and interests of the competition. The RMOC is not responsible for any party of the sponsorship.

### Violations and Penalties:

For actions that damage the brand of the RMOC and the Organizer DJI, and the trademark and intellectual property rights of sponsors, certain penalties such as disqualification from the competition and being subject to legal liability will be imposed on by the RMOC.

## 2.4.1 Naming rights

The participating team's named sponsor has the right to name the designated team (eg: XXX-team name, no more than 16 characters). The participating team's named sponsor is entitled to the naming rights of the designated team, granted by the RoboMaster organizing committee, and the corresponding naming method will be finalized in the Cooperative Sponsorship Agreement. Named sponsors can reveal the brand names of their channel through the team name, upon receiving competition notice from the organizing committee.

## 2.4.2 Participating Team Apparel Advertising Space

If the participating teams wear uniforms during the competition, their advertising space must conform to the specifications, as shown below. In the process of designing the team uniform of each team, the participating teams can independently design and produce the styles and materials of the costumes, as long as they do not violate the unified regulations of the competition.

Table 2-3 Participating Team Apparel Ads And Suggested Advertising Space

Element content	Suggested revealed location	Remarks
<b>Named sponsor logos</b>	Displayed directly on the chest, on the front of the costume	Permitted to invite investment
<b>General sponsor logos</b>	Displayed on the cuffs, clothing corners, etc.	Permitted to invite investment
<b>Partner logos</b>	Displayed on the back of the neck	Permitted to invite investment

## 2.4.3 Robot Body Advertising Space

The participating team can inkjet or paste the sponsor brand logo or product name on the robot body. See the [Decorative requirements](#) in [Table 3-1](#) for the advertising space decoration specifications.

If the participating team's investment results are outstanding, and there is a need to add advertising space on the basis of the price of the rights and interests guidance, they can apply for special approval from the organizing committee.

In order to ensure the fair competition of the game and the corresponding rules, the advertising space must meet the rules of the competition, such as not blocking the referee system and armor board, and not affect the visual recognition of the robot etc. In order to ensure aesthetic beauty, please make sure that the ads are pasted neatly. In order not to affect the robot's visual recognition functions, please do not use red, blue etc. in the advertising space. The inkjet or sticker cannot be illuminated and you should not choose fluorescent colors. The ruling on this regulation is subject to the results of the on-site check.

## 3. Technical Specification

Teams are expected to make and develop robots independently and can purchase basic components and modules from SZ DJI Technology Co., Ltd. with student discounts or from other manufacturers. For details of RoboMaster education products and purchasing, please refer to [RoboMaster 2019 Robotics Competition Instructions for Purchasing Materials](#) posted on the official website.

Robots must follow the specifications defined in this chapter, otherwise they shall fail the pre-match inspection.



It is recommended that participating teams consider the following aspects when designing robots:

- Plan and analyze the mechanical design before making robots, Use mature industrial products and modules to improve the reliability of mechanisms.
- Read this chapter carefully, plan well in advance, improve mechanism functions according to the rules and ensure that robots meet technical specifications.
- Read the [RoboMaster 2019 Robotics Competition Referee System Specification Manual](#) carefully, pay attention to the various installation specifications and usage methods of the referee system, in order to avoid failing the pre-match inspection due to improper installation.
- Evaluate manpower and fund demands in advance and make budgets and plans for robot making so as to avoid unnecessary iterations of robots during the preparation phase.
- Pay attention to the manufacturability of components to reduce costs and processing difficulty. Modularize components for easy replacement.
- Since robots will endure massive shootouts during the competition, good durability and maintainability are required.
- There will be certain manufacturing errors between the actual objects and the drawings. When designing the robot structure, consider the manufacturing errors of the Battlefield Components, and do not overly rely on the accuracy of the size measurements.
- During the process of robot design and structure production, try to add industrial design elements to improve the aesthetic extent. The aesthetic design should not interfere with the enemy with non-technical means. Robots installed with protective cases must satisfy the constraints specified in [Table 3-1](#) and [Appendix 5 Pre-match Inspection Form](#). You can also proceed to the official forum to check the related post: <https://bbs.robomaster.com/thread-7848-1-1.html>.

### 3.1 General Technical Specification

All robots must meet the following general technical specifications for energy source, wireless, optical equipment, visual feature and robot numbering.

Table 3-1 General Technical Specification of Robot

Type	Technical Specification
Energy Source	 <ul style="list-style-type: none"> <li>● An explosion-proof box will be placed at the entrance to each team in the Competition Area. During the competition, if a battery becomes a safety hazard, Technicians will put the hazardous battery into the explosion-proof box and will not return it to the participating team until the safety hazard is eliminated.</li> <li>● It is forbidden to use air pumps that have to work with external power supplies in the Competition Area. Teams can bring low-pressure air pumps but they are not allowed to charge air pumps in the Competition Area.</li> <li>● During the competition, if the gas cylinders are found to have safety hazards (such as damage to the external protection device, hidden dangers arising from aging, etc.), participants must follow the instructions of the referee to deal with safety hazards. Otherwise, the robot will not be allowed to play and must be removed from the Competition Area. The actual situation is determined by the Chief Referee.</li> </ul>
	<p>Robots may only use electrical or pneumatic power. Internal combustion engines, explosive substances and hazardous chemical materials are prohibited.</p> <p><b>Power Supply:</b></p> <ul style="list-style-type: none"> <li>● Only use dry batteries such as No. 1, No. 5, and No. 7 produced by reputable manufacturers or specified by the RMOC.</li> </ul> <hr/> <p> In the 2019 Season, battery that is specified by the RMOC is produced by DJI.</p> <hr/> <ul style="list-style-type: none"> <li>● The total battery capacity of Aerial should not exceed 600 Wh and that of other robots not exceed 200 Wh.</li> <li>● The supply voltage should not be higher than 48 V and there should be no risk of short circuiting.</li> </ul> <p><b>Violations and Penalties:</b></p> <p>Robots equipped with batteries of violation would fail the pre-match inspection. Violators will be held legally liable for safety incidents caused by such batteries.</p> <p><b>Gas Source:</b></p> <p>The compressed gas pressure must not exceed 20 Mpa. The cylinder used should have a nominal pressure of no less than 30 MPa. The working pressure must not exceed 0.8 Mpa. A double gauge constant pressure valve should be placed at the outlet of the cylinder.</p> <p>Robots using compressed gas for propulsion system must meet the following requirements:</p> <ul style="list-style-type: none"> <li>● Working gas: Working gas must be non-flammable and non-toxic, such as air, nitrogen or carbon dioxide.</li> </ul>



Type	Technical Specification
	<ul style="list-style-type: none"> <li>● Cylinder: Cylinder must have a valid conformity certificate or a steel plate. The plate should be viewable during the pre-match inspection and the certificate should be easily viewable.</li> <li>● Cylinder certification: Cylinder must be designed and manufactured for the pressure condition for usage, and certified by the officially recognized test organization of the country of origin.</li> <li>● Pressure regulator: The constant pressure valve must be directly installed on the gas cylinder or gas tank.</li> <li>● Protection measure: Gas cylinder and gas pipe must be protected to prevent damage caused by rollover, collision and rotation from any direction, and moving parts failures. The container opening shall not be exposed in order to prevent damage caused by projectiles.</li> <li>● Location of gas cylinder and pipe: The gas cylinder should be installed in a way that it and the gas pipe will not touch the ground no matter how the robot rolls.</li> <li>● Cylinder installation: The cylinder must be safely mounted on the frame and ensure the container opening remains either level or upward. To fix to the frame, the container must have at least two fixed points, or one fixed surface that is more than 1/5 of its length.</li> <li>● Thermal insulation: The cylinder must be insulated from any possible heat sources by a barrier layer, such as a carbon fiber board or aluminum plate.</li> <li>● Gas Pipes and fittings: Gas pipes and fittings must be able to handle the system's maximum possible working pressure.</li> </ul> <p>Violations and Penalties:</p> <p>Robots that violate these gas-power specifications will fail the pre-match inspection. Furthermore, if a referee determines that an unauthorized gas-power source is being used, this shall be deemed as cheating. Teams will be held liable for any danger caused by using gas-power sources that do not meet these specifications.</p>
<b>Wireless</b>	<p><b>Remote Controller:</b></p> <ul style="list-style-type: none"> <li>● Each Operator can use atmost one remore controller and each remote controller can only be targeted to one receiver.</li> <li>● Only use remoter controller that is specified by the RMOC.</li> </ul>



Type	Technical Specification
	<p data-bbox="419 226 467 271"></p> <p data-bbox="504 210 1412 275">In the 2019 Season, remote controller that is specified by the RMOC is produced by DJI.</p> <hr data-bbox="395 286 1423 291"/> <p data-bbox="343 311 667 338">Violations and Penalties:</p> <ul data-bbox="343 371 1433 674" style="list-style-type: none"> <li data-bbox="343 371 1433 456">● Robots not equipped with specified remote controllers cannot pass the pre-match inspection.</li> <li data-bbox="343 488 1433 674">● During the seven-minute match, if the remote controller used with robots is targeted to two or more receivers, the team will be considered cheating once confirmed by the Chief Referee or through investigation, and then it will be disqualified from the match.</li> </ul> <p data-bbox="343 707 691 734"><b>Wireless Communication:</b></p> <p data-bbox="343 768 1433 1010">Unofficial wireless networks may interfere with the operation of the equipment related to the official referee system or participating robots. Participants are forbidden from setting up wireless networks in the relevant areas (including but not limited to the Preparation Area, Inspection Area, Staging Area, and Competition Area), and using radios to communicate with each other.</p> <p data-bbox="343 1043 667 1070">Violations and Penalties:</p> <ul data-bbox="343 1104 1433 1406" style="list-style-type: none"> <li data-bbox="343 1104 1433 1245">● If participants are found to set up wireless networks, they will be considered cheating once confirmed by the chief referee or through investigation, and then they will be disqualified from the match.</li> <li data-bbox="343 1276 1433 1406">● If participants are found to use radios to communicate and interfere with the normal process of the match, they will be considered cheating once confirmed by the chief referee or through investigation, and then they will be disqualified from the match.</li> </ul>
<p data-bbox="161 1529 312 1608"><b>Optical Equipment</b></p>	<ul data-bbox="343 1451 1433 1693" style="list-style-type: none"> <li data-bbox="343 1451 1433 1693">● The laser beam from the laser sight must be red and the optical power consumption of the laser beam is less than 35 mW. The projection angle of the laser sight must not exceed 5° (i.e. the diameter of the laser spot perpendicularly projected by the laser sight on a vertical wall with a horizontal distance of one meter is less than 9 cm).</li> </ul>



Type	Technical Specification
	<ul style="list-style-type: none"> <li>● During the competition, Aerial can be equipped with indicator lights on its body to better implement visual function and indicate its current flight status. Indicator lights on the body can only be placed at six locations at most, the number of lights on each of these six locations must not exceed three and the luminance of each bulb cannot exceed 3500 Lux at 10 cm away). Indicator lights should not interfere with the competition on the Battlefield (high-power LED that directly illuminates the Battlefield is prohibited).</li> </ul> <hr/> <div style="display: flex; align-items: center;">  <p>Reference data: The maximum illumination value of the flight status indicators for the latitude and Matrice 100 drone are 3200 Lux outside the distance of 10 cm.</p> </div> <hr/> <ul style="list-style-type: none"> <li>● In addition to the laser sight, Engineers can be equipped with a visible light emitting device, and a fill light can be used to enhance the visual recognition feature when going to an island or acquiring a Projectile Container. Other ground robots must not be equipped with other obvious visible light emitting equipment.</li> <li>● Optical elements used by robots must not cause harm to participants, referees, staff or audience members.</li> </ul> <p style="color: #00AEEF;">Violations and Penalties:</p> <ul style="list-style-type: none"> <li>● Any robot that uses illegitimate optical equipment will not pass the pre-match inspection.</li> <li>● If any piece of optical equipment on the robot causes any physical injury to the participating team members, referees, staff or the audience, the offending party shall be investigated for legal liabilities.</li> </ul>
<p><b>Visual Feature</b></p>	<p>The Referee System Armor Module is designed with clear lighting effects for the development of automatic identification and sighting algorithms. The environment in and around the Competition Area is relatively complicated. The computer vision algorithm should adapt to the changes of the lighting of the venue and other possible interferences around the venue. The RMOC cannot guarantee that the computer vision features of the Battlefield will not cause visual interference.</p> <p>When designing the robot's visual feature, teams should follow specifications as shown below:</p> <ul style="list-style-type: none"> <li>● Robot sensors (such as lidar, camera, ultrasonic sensor, infrared sensor, etc.) must be installed without blocking the armor and must not project light on the armor.</li> </ul>

Type	Technical Specification
	<ul style="list-style-type: none"> <li>Do not project light onto the armor and do not install any device that interferes with the computer vision feature identification of the Armor Module by reflecting or refracting the light on both sides of the armor on the robot.</li> </ul> <p>Violations and Penalties:</p> <p>Robots that violate the rules will fail the pre-match inspection.</p>
<b>Robot Numbering</b>	<p>During the pre-match inspection and the competition, the RMOC staff will paste number stickers on robots that enter the competition and also the armor plates at the Base according to the robot numbering rules. The robot number is shown in <a href="#">Table 3-2</a> and for number stickers, please refer to <a href="#">Appendix 6 Reference Drawing</a>.</p> <p>When applying stickers on robots, teams should follow specifications as shown below:</p> <ul style="list-style-type: none"> <li>Stickers must be applied properly on the armor plates without bubbles, with one sticker on each side. Stickers shall be identical with the number of robots.</li> <li>Except for the designated number stickers provided by the RMOC, similar stickers may not be attached to the armor plates or other structures of the robot. Other decorative stickers on the robot shall not include distinct numbers.</li> </ul> <p>Violations and Penalties:</p> <ul style="list-style-type: none"> <li>Robots that have unqualified stickers will fail the pre-match inspection.</li> <li>During the competition, all robots are required to be pasted with their corresponding stickers; otherwise they are not allowed to play.</li> <li>In the competition, except for damages caused to stickers during a match, the robot will be deemed as cheating if any kind of unqualified sticker is found to be pasted on the robot. The offending team will receive a punitive forfeiture for any round of the challenge where it shows up with unqualified stickers.</li> </ul>
<b>Aesthetic Design</b>	<p>In order to prevent the robot’s protective case from affecting the shootouts on the Battlefield or the audience’s viewing experience, teams must comply with the following requirements of aesthetic design:</p> <p><b>Basic requirements:</b></p> <ul style="list-style-type: none"> <li>The lines of the robot are neat and not exposed. Exposure that is unavoidable requires line protection with materials such as drag chains and cable managers.</li> <li>There must be no materials that have an obvious influence on the appearance of the robot, such as washbasins, plastic bottles, corrugated paper, bed sheets, flesh-colored stockings, white foam boards, air cushion membranes, etc.</li> </ul>

Type	Technical Specification
	<ul style="list-style-type: none"> <li>● Fish nets should not be used as aesthetic design materials, unless necessary functional requirements exist.</li> </ul> <p style="color: #00AEEF;">Violations and Penalties:</p> <p style="color: #00AEEF;">Robots that do not meet the basic aesthetic design requirements will not pass the pre-match inspection.</p> <p><b>Glossiness:</b></p> <p>The protective case can be made of any material. In order to prevent the protective case from reflecting the light emitted by the referee system which may affect the computer visual recognition, the surface glossiness of the case is required to be no more than 15 Gs. During the pre-match inspection, the inspector will measure the glossiness of the case with a glossmeter.</p> <hr/> <div style="display: flex; align-items: flex-start;"> <div style="margin-right: 10px;">  </div> <ul style="list-style-type: none"> <li>● Matte paint and stickers are provided at the Inspection Area. If a team fails to meet the requirements, it can implement matte treatment to the surface.</li> <li>● The principle of glossmeter: A built-in light source emits a certain amount of light, which is projected onto the surface of the object to be detected. Then a built-in receiver receives the reflected light, and measures the glossiness of the surface according to the amount of reflected light. The glossmeter's measurement range is 0-101 Gs. It is known that the glossiness of a mirror surface is 101 Gs and that of a total diffuse reflection object is 0 Gs.</li> </ul> </div> <hr/> <p><b>Coating color (Engineer is not required):</b></p> <ul style="list-style-type: none"> <li>● The Red team robot's protective shell color can use red series, the blue team robot can use blue series, but the opposing team's color should not be used, to avoid confusion. Except for black and metallic colors, the number of other colors must not exceed two.</li> <li>● It is recommended that the team's robots have a consistent aesthetic style.</li> <li>● The robot must have two school badges or team badges from their own side (one for each perspective). The school badges or team badges must be in a prominent position across the robot. The school badges or team badges have no limitation on the number of colors. The school badges or team badges can be anti-white processed or preserve the original colors.</li> </ul> <hr/> <div style="display: flex; align-items: flex-start;"> <div style="margin-right: 10px;">  </div> <ul style="list-style-type: none"> <li>● It is recommended that teams use a large area of dark color (with texture) as the bottom color and use acceptable colors to outline and embellish the case.</li> <li>● Textures such as camouflage, fiber texture, wood grain, metal wire drawing, etc. are processed as a single color.</li> <li>● If there is a sponsor logo on the robot, it is recommended to use a black background and white color (that is, logo anti-white processing), and white shall not be limited by the number of colors; otherwise, the colors of the logo pattern must be accounted for in the color amount. If there are</li> </ul> </div>

Type	Technical Specification
	<p>special circumstances (such as special requirements of sponsors, etc.), the participating team must report to the organizing committee.</p> <ul style="list-style-type: none"> <li>● Special materials, such as boards and 3D printed parts, must meet the color amount standard. The transparent color of the materials must also be accounted for in the color amount. It is recommended to use materials with a unified black surface, such as black printed silk, cable ties, etc.</li> </ul> <hr/> <p><b>Installation:</b></p> <p>The installation of the protective case needs to meet the normal inspection standards. For example, the armor panel cannot be blocked within 105° in the positive direction.</p> <hr/> <p> It is recommended that teams use tough materials that are not easily damaged for the protective case and at the same time implement confrontation and strike test on the case, so as to avoid violations resulting from damage caused in the Competition Area.</p> <hr/> <p><b>Decorative requirements:</b></p> <p>Each robot can be set with up to two advertising spaces for the display of sponsor information and the advertising space should be displayed on the left and right sides of the robot. The size of a single robot advertising space shall be no more than 10cm*10cm, and there are no more than two sponsor logos displayed.</p> <p>Display of sponsors must be reported to the RMOC for approval at least two weeks before the start of the competition. If the application is not approved, it cannot be revealed on the vehicle body and the robot cannot otherwise pass the pre-match inspection.</p> <p><a href="#">Violations and Penalties:</a></p> <p><a href="#">Robots that do not meet the aesthetic design requirements will fail the pre-match inspection.</a></p>
<p><b>Launching Mechanism</b></p>	<ul style="list-style-type: none"> <li>● Robots using compressed gas as the propellant for projectiles must not have an acceleration length (defined as the lineal length of the barrel that can provide acceleration to projectiles) exceeding 20 cm.</li> </ul> <hr/> <p> <b>Launching Mechanism:</b> a mechanism that allows projectiles to leave the robot on a fixed trajectory to cause damage to other robots. (This definition is applicable to all instances of "Launching Mechanism" mentioned in this manual.)</p> <hr/> <ul style="list-style-type: none"> <li>● When the robot launches ten 17 mm projectiles or launches five 42 mm projectiles, the maximum speed difference detected by the speed measuring module shall not be more than 5 m/s.</li> </ul> <p><a href="#">Violations and Penalties:</a></p> <p><a href="#">Robots that do not meet the launching mechanism requirements will fail the pre-match</a></p>

Type	Technical Specification
	inspection.

## 3.2 Robot Technical Specification

RoboMaster requires robots to fight together as a team. Good teamwork is therefore critical to victory. Robots are divided into two types: compulsory and optional. If an optional robot hasn't participated in a competition, its HP will be displayed as zero in the referee system server of that round. Below shows the robot entrance lineup.

Table 3-2 Robot Entrance Lineup

Type	Numbering	Qty.	Property	Eligible Competition
<b>Standard</b>	3/4/5	3	Required	International Regional Competition, Wild Card Competition and the Final Tournament
		2		Chinese Regional Competition
<b>Hero</b>	1	1	Required	Chinese Regional Competition, International Regional Competition, Wild Card Competition and the Final Tournament
<b>Engineer</b>	2	0-1	Optional	Chinese Regional Competition, International Regional Competition, Wild Card Competition and the Final Tournament
<b>Aerial</b>	6	0-1		
<b>Sentry</b>	7	0-1		

Different types of robots must meet the corresponding technical specifications:

- Before each match, different types of required robots must all pass the pre-match inspection so that teams can qualify for the match. After the first round of each match, subsequent rounds do not require the minimum lineup. If there are serious damages to a robot in the first round or there are serious safety hazards such as short circuit, the robot must be immediately powered off and brought to the area designated by the Chief Referee to avoid safety risks in subsequent matches. The actual situation determined by the Chief Referee.
- Each team is allowed to carry two standby robots at most during each match. Standby robots must also comply with all robot specifications and pass the pre-match inspection. Participants are required to declare the types of standby robots that they are carrying and that need to enter the stage during the pre-match inspection. Apart from standby Standard, other types of standby robots must be

attached with armor stickers in the Inspection Area. When a standby Standard is required to enter the stage, team members must promptly get the corresponding sticker from the technicians and attach it in accordance with [Robot Numbering](#) stated in [Table 3-1](#). Only then can the robot enter the stage.

- Standby robots are not allowed to replace after passing the pre-match inspection. The RMOC will issue a referee system to the spare robots that have passed the check in the pre-checking section of the competition division. The participating teams that do not report in advance to carry the spare robots will not be able to borrow the referee system of the spare robots. The participating team will immediately recycle the referee system of the spare robot after finishing the competition in the competition division.

#### Violations and Penalties:

- Before each match, if the number of the required robots that pass the pre-match inspection does not meet the regulation, the team is deemed as give up its qualification for the round of the match and lose the match.
- If a participating team replaces or adds a standby robot after passing the pre-match inspection or the standby robot does not pass the pre-match inspection, the team will be deemed as cheating and lose the match. The actual situation is determined by the Chief Referee.

### 3.2.1 Standard

Standard is required and below shows its specification:

Table 3-3 Standard Specification

Item	Limit	Violations and Penalties	Notes
<b>Initial HP</b>	200	-	-
<b>Object</b>	except Aerial	-	-
<b>Operating Mode</b>	Manual, configured up to one remote controller	-	-
<b>Maximum Total Power Supply Capacity (Wh)</b>	200	Unable to pass the pre-match inspection	-

Item	Limit	Violations and Penalties	Notes
<b>Maximum Power Supply Voltage (v)</b>	30	Unable to pass the pre-match inspection	-
<b>Maximum Chassis Power Consumption (W)</b>	80	HP deduction	Buffer energy 60 joules
<b>Strength</b>	Drop freely at a vertical height of 0.2 m three times without any damage to any position of the body.	-	
<b>Launching Mechanism Type</b>	17 mm projectile	-	Can install only one Launching Mechanism and one laser sight
<b>Projectile Supply Capability</b>	<ul style="list-style-type: none"> <li>● Can only receive projectiles</li> <li>● Can enter the official projectile supplier to complete the projectile supply action</li> </ul>	Unable to pass the pre-match inspection	-
<b>Initial Projectile Quantity</b>	0	-	All projectiles need to be removed before the start of each round.
<b>Initial Firing Speed Limit for Projectiles (m/s)</b>	30	HP deduction	-

Item	Limit	Violations and Penalties	Notes
<b>Projectile Speed of Launch (shoot/s)</b>	Negatively correlated with initial velocity	Refer to <a href="#">4.3.1 Barrel Heat</a>	-
<b>Maximum Weight (kg)</b>	20	Unable to pass the pre-match inspection	Include the battery weight, but not the weight of the Referee System
<b>Maximum Initial Size (mm)</b>	600*600*500	Unable to pass the pre-match inspection	<ul style="list-style-type: none"> <li>● Height must not exceed 500</li> <li>● Its orthographic projection on the ground should not exceed a 600*600 square</li> </ul>
<b>Maximum Expansion Size (mm)</b>	700*700*600	Unable to pass the pre-match inspection	<ul style="list-style-type: none"> <li>● Height must not exceed 600</li> <li>● Its orthographic projection on the ground should not exceed a 700*700 square</li> </ul>



Item	Limit	Violations and Penalties	Notes
<b>Referee System</b>	Four small Armor Modules, one large Armor Module, Speed Monitor Module (17 mm projectile), Video Transmission Module (VTM), RFID Interaction Module, Positioning System Module, Main Controller Module, Power Management Module, Light Indicator Module	Teams that fail to meet the installation requirement of Referee System will be unable to pass the pre-match inspection	Weight: 3.7 kg



- Initial firing speed limit: When the projectile has accelerated, the detected speed must be less than or equal to the limit. The limit of 17 mm projectile is 30 m/s and that of 42 mm projectile is 16.5 m/s.
- Maximum expansion size: It indicates that the size of the robot after deformation shall be less than or equal to the limit value during the game.

Table 3-4 Standard Level Parameter

Level	Maximum HP	Barrel Heat Limit	Barrel Cooling Value Per Second	Experience Points required for Level Up	Value of Experience Points
1	200	240	40	3	2.5
2	250	360	60	6	5
3	300	480	80	/	7.5



- During a match, when Standard's HP is less than 20%, its 17 mm barrel cooling value per second will double.
- For level up mechanism of Standard, please refer to [4.2 Level Up](#).

### 3.2.2 Sentry

Sentry is optional and its experience value is 7.5 with no level. Below shows its specification:

Table 3-5 Sentry Specification

Item	Limit	Violations and Penalties	Notes
<b>Initial HP and Maximum HP</b>	600	-	-
<b>Object</b>	except Aerial	-	-
<b>Operating Mode</b>	Fully Automatic	-	-
<b>Maximum Total Power Supply Capacity (Wh)</b>	200	Unable to pass the pre-match inspection	The total capacitance of the robot does not exceed 10 mF
<b>Maximum Power Supply Voltage (v)</b>	30	Unable to pass the pre-match inspection	-
<b>Maximum Chassis Power Consumption (W)</b>	20	Unable to pass the pre-match inspection	Buffer energy 200 joules
<b>Launching Mechanism Type</b>	17mm projectile	-	Can install only one Launching Mechanism and one laser sight
<b>Projectile Supply Capability</b>	Can only receive	-	Any form that delivers projectiles to other robots is prohibited
<b>Initial Projectile Quantity</b>	500	-	<ul style="list-style-type: none"> <li>● All projectiles need to be removed during the 3-minute setup period of the first round of each match.</li> <li>● After the first round, projectiles do not need to be removed before the start of each subsequent round.</li> </ul>

Item	Limit	Violations and Penalties	Notes
			<ul style="list-style-type: none"> <li>Each team pre-loads the initial projectiles during the 3-minute setup period.</li> </ul>
<b>Initial Firing Speed Limit for Projectiles(m/s)</b>	30	HP deduction	-
<b>Projectile Speed of Launch (shoot/s)</b>	Negatively correlated with initial velocity	Refer to <a href="#">4.3.1 Barrel Heat</a>	-
<b>Barrel Heat Limit</b>	480	-	-
<b>Barrel Cooling Value Per Second</b>	160	-	
<b>Maximum Weight (kg)</b>	10	Unable to pass the pre-match inspection	Includes the battery weight, but not the weight of the Referee System
<b>Maximum Size (mm)</b>	500*500*600	Unable to pass the pre-match inspection	<p>The maximum size of Sentry below the upper surface of the Sentry track is no more than 450 mm (include the maximum expansion size). The light indicator module is mounted on one side of the track and must be above the upper surface of the track.</p> <p>The light indicator module, positioning system module and its bracket are not included into the overall size constraints.</p>

Item	Limit	Violations and Penalties	Notes
<b>Referee System</b>	Two large Armor Modules, Speed Monitor Module (17 mm projectile), Positioning System Module, Main Controller Module, Power Management Module, Light Indicator Module	Teams that fail to meet the installation requirement of Referee System will be unable to pass the pre-match inspection	Weight: 2.2 kg

### 3.2.2.1 Sentry and Base Shield

#### If Sentry enters the stage:

- When a team loses its first robot (except Sentry and Aerial), the team's base defense will be reduced from 100% to 50%.
- When Sentry is destroyed, the base's entire defense will be automatically eliminated and the base shield opened.

#### If Sentry does not enter the stage:

- When a team loses its first robot (except Aerial) within two minutes of the start of the match, the team's base defense will be reduced from 100% to 50%.
- Two minutes after the start of the match, the base's entire defenses will be automatically eliminated and the base shield opened.



For the shape of expanded Base, please refer to [4.6.3 Base](#).

### 3.2.2.2 Sentry's HP Gain

If Sentry destroys any enemy robot (except for Aerial, the results is calculated by the referee system server), it can obtain some HP Gain. The Sentry's HP Gain = the corresponding Value of Experience Points of the killed robot \* 20.

For example, If Sentry destroys one Level 1 Standard of the enemy, the Sentry's HP Gain =  $2.5 * 20 = 50$ .

### 3.2.3 Hero

Hero is required and below shows its specification:

Table 3-6 Hero Specification

Item	Limit	Violations and Penalties	Notes
Initial HP	300	-	-
Obeject	except Aerial	-	-
Operating Mode	Manual, configured up to one remote controller	-	-
Maximum Total Power Supply Capacity (Wh)	200	Unable to pass the pre-match inspection	-
Maximum Power Supply Voltage (v)	30	Unable to pass the pre-match inspection	-
Maximum Chassis Power Consumption (W)	80	HP deduction	Buffer energy 60 joules
Launching Mechanism Type	17 mm and 42 mm projectiles	-	Each Launching Mechanism can only be equipped with one laser sight
Projectile Supply Capability	Receive and supply	-	-
Initial Projectile Quantity	0	-	All projectiles need to be removed before the start of each round
Initial Firing Speed Limit for Projectiles (m/s)	16.5	HP deduction	42 mm projectile
	30	HP deduction	17 mm projectile

Item	Limit	Violations and Penalties	Notes
<b>Projectile Speed of Launch (shoot/s)</b>	Negatively correlated with initial velocity	Refer to <a href="#">4.3.1 Barrel Heat</a>	-
<b>Maximum Weight (kg)</b>	35	Unable to pass the pre-match inspection	Include the battery weight, but not the weight of the Referee System
<b>Maximum Initial Size (mm)</b>	800*800*800	Unable to pass the pre-match inspection	<ul style="list-style-type: none"> <li>● Height must not exceed 800</li> <li>● Its orthographic projection on the ground should not exceed a 800*800 square</li> </ul>
<b>Maximum Expansion Size (mm)</b>	1200*1200*1200	Unable to pass the pre-match inspection	<ul style="list-style-type: none"> <li>● Height must not exceed 1200</li> <li>● Its orthographic projection on the ground should not exceed a 1200*1200</li> </ul>
<b>Referee System</b>	Five large armor modules, Speed Monitor Module (17 mm and 42 mm projectiles), Video Transmission Module (VTM), RFID Interaction Module, Positioning System Module, Main Controller Module, Power Management Module, Light Indicator Module	Teams that fail to meet the installation requirement of Referee System will be unable to pass the pre-match inspection	Weight: 5.0 kg



Hero configured with two types of projectile Launching Mechanism will have barrel heat calculated separately for each type.

Table 3-7 Hero Level up Parameter

Level	Maximum HP	17 mm Barrel Heat Limit	17 mm Barrel Cooling Value Per Second	42 mm Barrel Heat Limit	42 mm Barrel Cooling Value Per Second	Experience Points required for Level Up	Value of Experience Points
1	300	240	40	150	20	8	7.5
2	500	360	60	250	40	12	10
3	700	480	80	400	60	/	15



For level up mechanism of Hero, please refer to [4.2 Level Up](#).

### 3.2.4 Aerial

Aerial is optional and below shows its specification:

Table 3-8 Aerial Specification

Item	Limit	Violations and Penalties	Notes
Initial HP	-	-	-
Object	except Aerial	-	The referee system can only control the friction wheel motor
Operating Mode	up to 2 remote controllers	-	-
Maximum Total Power Supply Capacity (Wh)	600	Unable to pass the pre-match inspection	-
Maximum Power Supply Voltage (v)	60	Unable to pass the pre-match inspection	-

Item	Limit	Violations and Penalties	Notes
<b>Maximum Chassis Power Consumption (W)</b>	-	-	-
<b>Launching Mechanism Type</b>	17 mm projectile	-	Can install only one Launching Mechanism and one laser sight
<b>Projectile Supply Capability</b>	Can only receive	-	-
<b>Initial Projectile Quantity</b>	500	-	-
<b>Initial Firing Speed Limit for Projectiles (m/s)</b>	30	Attack time deduction	-
<b>Projectile Speed of Launch (shoot/s)</b>	No limits	-	-
<b>Maximum Weight (kg)</b>	10	Unable to pass the pre-match inspection	Include the battery weight, but not the weight of the Referee System
<b>Maximum Initial Size (mm)</b>	1200*1200*800	Unable to pass the pre-match inspection	<ul style="list-style-type: none"> <li>● Height must not exceed 800</li> <li>● Its orthographic projection on the ground should not exceed a 1200*1200 square</li> </ul>



Item	Limit	Violations and Penalties	Notes
<b>Referee System</b>	Speed Monitor Module (17 mm projectile), Video Transmitter Module (VTM), Positioning System Module, Main Controller Module, Power Management System	Teams that fail to meet the installation requirement of Referee System will be unable to pass the pre-match inspection	Weight: 0.6 kg

### 3.2.4.1 Energy Mechanism

At the start of the competition, the energy of Aerial is  $E = 0$ . After Aerial lands stably on the Landing Pad, it gains one Energy per second. If Aerial starts the blade off the Landing Pad before it reaches 100 points of energy, then the natural increase of energy every second will be paused and the accumulated energy shall not be cleared to zero. Aerial continues to accumulate energy when it returns to the Landing Pad again.

When  $E < 100$ , the Launching Mechanism is powered off and cannot launch projectiles. When  $E = 100$ , the Aerial Gimbal Operator chooses whether to power up the Launching Mechanism.

When the Launching Mechanism is powered on, Energy of Aerial falls to zero and it can launch projectiles at any speed within 50 seconds. The Initial Firing Speed Limit is 30 m/s. After 50 seconds of attack time or after Aerial has launched 500 shoots of 17 mm projectiles, the Launching Mechanism will power off. After the power is turned off, if Aerial returns to the Landing Pad, it will accumulate Energy again. If Aerial returns to the Landing Pad before 50 seconds has elapsed, the 50 seconds attack time continues to count down and cannot reaccumulate Energy until the attack time runs out.

The logic diagram of Aerial energy is as follows:

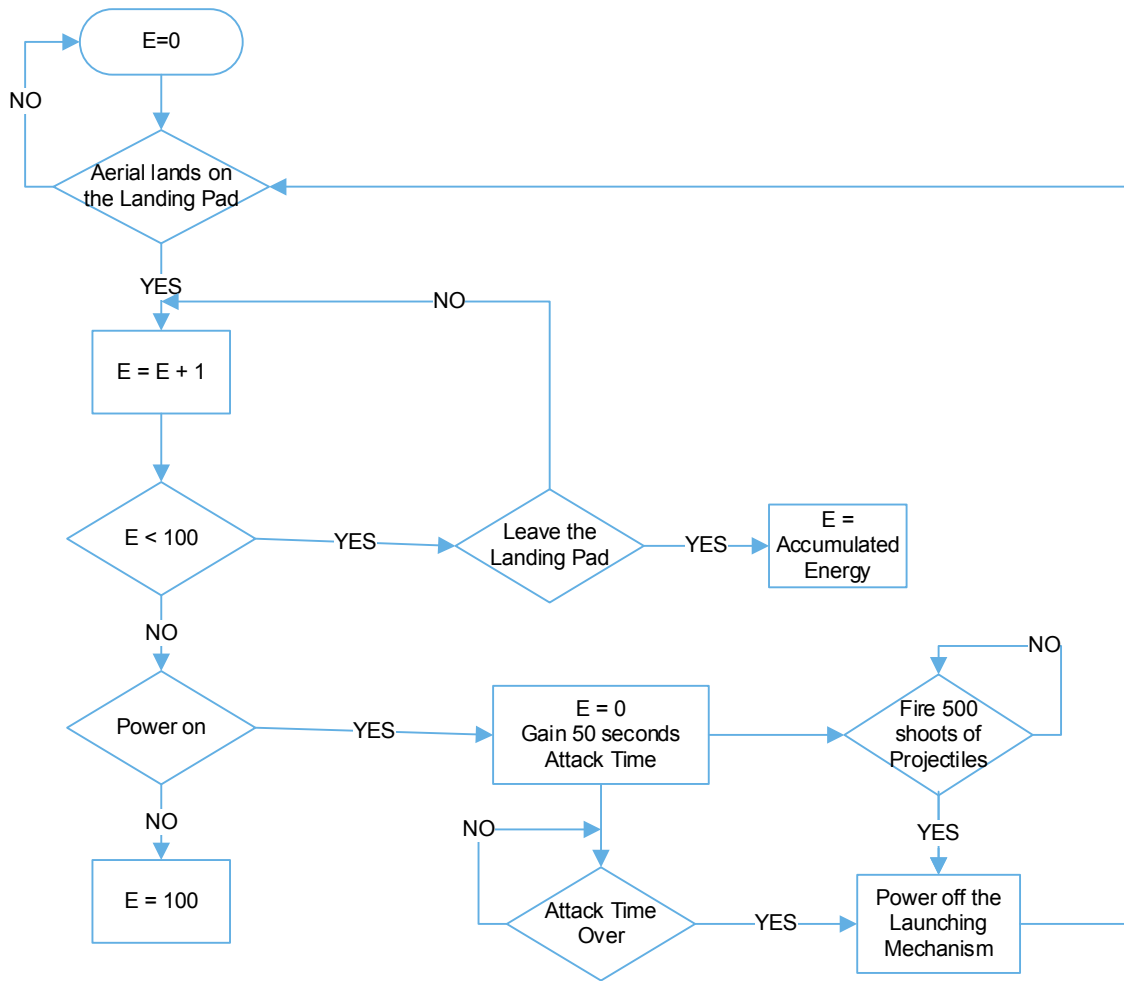

Figure 3-1 Aerial Energy Mechanism

### 3.2.4.2 Accumulating Energy

Once a robot is destroyed by the enemy, Aerial gains Energy immediately (Aerial's Energy gain = Value of Experience Points of the destroyed robot\*3). Energy gain is accurate to one decimal place.

e.g. At the start of the competition, Aerial of the Red team took off from the landing pad after landing on it for 75s, E = 75 at that time. During the competition, the moment when a Level 2 Standard is destroyed by the Blue team, Energy of Aerial of the Red team is  $E = 75 + 5 * 3 = 90$ .



The limit of E is 100 and the exceeding proportion will be eliminated automatically.

### 3.2.4.3 Exceeding Initial Firing Speed Limit

If the referee system detects that the initial velocity of the aerial robot's projectile exceeds the upper limit, the attackable time of the aerial robot must be reduced. If the attack time is about to expire, the time deduction will be applied to the next attack time. Multiple exceedings will result in multiple attack time reductions. If Aerial's current Initial Firing Speed is  $V_1$  and the Initial Firing Speed limit for projectiles is 30 m/s, when the Speed Monitor Module of the referee system detects one 17 mm projectile that exceeds the limit, the Aerial's attack time is reduced by  $t = 0.5 (V_1 - 30)^2$  s. Deducted attack time is accurate to

one decimal place.

### 3.2.4.4 Loading Projectile

During the 3-minute setup period, the referee will provide 500 shoots of initial projectiles to the Pilot to preload. In the process of a round, in addition to the initial projectiles, the referee will provide infinite extra projectiles as supplies.

During a match, when Aerial is landed on the landing pad with the propellers off, is Aerial has launched 500 shoots of projectiles or each attack time has run out, Projectile Supplier standing in the specified area ( see [Figure 5-37](#)) can tell the referee in the Operator Room to reload Aerial. When the referee approves, the team members can load Aerial with projectiles within 30 seconds. For more details, please refer to [4.12 Operator Room](#).

### 3.2.4.5 Module offline

If Aerial has its module offline when accumulating energy, then the natural increase of the energy every second will be paused; if the module is offline during the attackable time, the launchable projectiles of the aerial robot will be reduced, and the relationship between the number of modules off-line  $M$  and the number of projectiles reduced per second  $N$  is:  $N = 25 * M$ .

### 3.2.4.6 Safety Regulations

Aerial should follow safety regulations as shown below:

- No part of Aerial's barrel can exceed the top of the Perimeter Wall.
- Aerial must be fitted with fully enclosed propeller guards. Aerial hits the rigid plane at a horizontal velocity of  $(1.2 \pm 0.1)$  m/s without significant damage.
- If Aerial crashes into a tall cylindrical object, the propeller guards should protect the propellers from making direct contact with the object. The propeller guards should be strong enough to avoid serious damage and bear the weight of the aircraft.
- Above the battlefield, there are cables, slip rings and retractable Aerial Safety Ropes to ensure Aerial's safety. Aerial must have a vertical safety rod with a height of 300 mm above the propellers installed on top of the body. The safety rod is rigidly connected to Aerial; a wire ring is fixed on the upper end of the safety rod as a pull ring for Aerial Safety Ropes. When Aerial is suspended by the pull ring, the safety rod and the pull ring can bear its static weight. Connect the robot to the drawstring, raise it vertically by 0.05 meters, and let free fall once without significant deformation and damage.
- Neither team can attack the other team's Aerial.
- Aerial must not interfere with the normal operation of the ground robot during flight.

- Teams should reasonably evaluate and fully test whether the propulsion system and power supply system of Aerial can meet the requirements of load and combat behaviors to prevent safety hazards or accidents during the competition.

**Violations and Penalties:**

- If any part of Aerial’s barrel exceeds the height of the Perimeter Wall, the Chief Referee or Pilot Room referees will warn the Pilot to reduce height. If the Pilot ignores the warning, Aerial will be ejected from the Battlefield with a Level 4 Warning (The Video Transmission Module and Launching Mechanism are powered off and Aerial must immediately land on the Landing Pad), and the team is not allowed to use Aerial for the remaining rounds of the match.
- Robots that actively fire at Aerial will be given a Level 4 Warning.
- If Aerial collides with a ground robot during a match, the referee will consider it a malicious collision and give the offending Aerial a Level 3 Warning.
- If Aerial stays on the ground and affects the normal operation of the ground robot, the referee will give a verbal warning. If the three verbal warnings are ignored, the offending aerial robot will be sentenced to a Level 4 Warning.
- If Aerial malfunctions or is repeatedly damaged due to the unreasonable design of the propulsion system or power supply system, it must be checked by the site technicians. Aerial has to be confirmed hazard-free by the Chief Referee before being allowed to return to the match. Otherwise, it will be prohibited from competing in other rounds of the match or being provided with any projectile. The actual situation is determined and executed by the Chief Referee.
- If Aerial of a team is out of control (e.g. when Pilot can’t properly control Aerial), crashes or falls inside the Battlefield, and Pilot can’t restart the Aerial’s propeller and control it to take off and function normally, Aerial will be ejected from the Battlefield by the referee system server. Aerial Safety Ropes will be used by Pilot and site technicians to lift Aerial to a certain height to avoid safety concerns caused by possible collision between the fallen Aerial and the ground robots.

### 3.2.5 Engineer

Engineer is optional and its experience value is 5 with no level. Below shows its specification:

Table 3-9 Engineer Specification

Item	Limit	Violations and Penalties	Notes
Initial HP and Maximum HP	1000	-	-
Object	Teammates	-	-

Item	Limit	Violations and Penalties	Notes
<b>Operating Mode</b>	configured up to one remote controller	-	-
<b>Maximum Total Power Supply Capacity (Wh)</b>	200	Unable to pass the pre-match inspection	-
<b>Maximum Power Supply Voltage (v)</b>	30	Unable to pass the pre-match inspection	-
<b>Maximum Chassis Power Consumption (W)</b>	No limits	-	-
<b>Launching Mechanism Type</b>	Not available	-	-
<b>Projectile Supply Capability</b>	Can receive and supply	-	-
<b>Initial HP and Maximum HP</b>	0	-	All projectiles need to be removed before the start of each round
<b>Maximum Weight (kg)</b>	35	Unable to pass the pre-match inspection	Include the battery weight, but not the weight of the referee system
<b>Maximum Initial Size (mm)</b>	800*800*800	Unable to pass the pre-match inspection	<ul style="list-style-type: none"> <li>● Height must not exceed 800</li> <li>● Its orthographic projection on the ground should not exceed a 800*800 square</li> </ul>

Item	Limit	Violations and Penalties	Notes
<b>Maximum Expansion Size (mm)</b>	1200*1200*1200	Unable to pass the pre-match inspection	<ul style="list-style-type: none"> <li>● Height must not exceed 1200</li> <li>● Its orthographic projection on the ground should not exceed a 1200*1200 square</li> </ul>
<b>Referee System</b>	Four small armor modules, Video Transmission Module (VTM), RFID Interaction Module, Positioning System Module, Main Controller Module, Power Management Module, Light Indicator Module	Teams that fail to meet the installation requirement of Referee System will be unable to pass the pre-match inspection	Weight: 2.6 kg

### 3.2.5.1 Restoration of HP

Engineer restores 1% of its maximum HP per second if it avoids damage for at least 30 seconds during a single round (include damage caused by collisions, module goes offline, etc.).

### 3.2.5.2 Grabbing Mechanism

Engineer's Grabbing Mechanism should meet the following regulations:

- During the competition, only Engineer can install one Grabbing Mechanism for Projectile Containers.
- Engineer's Grabbing Mechanism is only allowed to grab one Projectile Container at a time.
- When the body of the projecting Grabbing Mechanism is in close contact with a vertical plane, the maximum horizontal distance between the Grabbing Mechanism and the vertical plane is 400 mm. In other words, no part of the Grabbing Mechanism can cross the midline of the projectile depot in the central area of the Resource Island.
- The Grabbing Mechanism cannot damage Battlefield Components. In particular, it cannot use serrated or sharp-edged structures to interact with projectile containers, which will cause irreversible damage.

#### Violations and Penalties:

- If the Engineer's Grabbing Mechanism does not meet requirements, it will fail the pre-match inspection.
- During a match, if the Engineer's Grabbing Mechanism is discovered to have serrated or sharp edges that cause irreversible deformation or severe damage to Projectile Containers, the violating robot will be ejected.



# 4. Referee System

## 4.1 Overview

The referee system is an electronic referee system that can automatically monitor the state of the robots and make a judgment - in other words, an “Intelligent Referee”. During the competition, the referee system provided by the RMOC monitors a robot’s behaviors, such as HP, projectile initial firing speed, and chassis power consumption and then sends real-time information to the computer of the corresponding operator and the referee system server. It also automatically determines the outcome of the competition. When designing robots, teams must reserve mechanical and electrical interfaces to the referee system and install the system as required in the latest version of the [RoboMaster 2019 Robotics Competition Referee System Specification Manual](#). Otherwise, they will not pass the pre-match inspection. For details of the size and mounting interface of the referee system, please refer to the latest version of the [RoboMaster 2019 Robotics Competition Referee System Specification Manual](#).

The RoboMaster 2019 referee system consists of the following modules:

Table 4-1 Referee System Modules

Module	Function
<b>Camera Video Transmitter Module</b>	Capture real-time video feed from the camera and transmit the data to the operator’s monitor in the operator room.
<b>Speed Monitor Module</b>	<p>Detect the projectile initial firing speed and if it overspeeds, the robot’s HP will be deducted.</p> <hr/>  <ul style="list-style-type: none"><li>● The Speed Monitor Module can only be installed at the end of the Launching Mechanism, and the speed cannot be measured until the projectile has fully accelerated.</li><li>● The installation position of the speed measuring module may be adjusted later and is subject to the latest version officially released by the RMOC.</li></ul>
<b>Armor Module</b>	<p>Detect the situation when the robot is hit, and deduct corresponding HP values.</p> <hr/>  <p>It is recommended that the participating teams increase the protection measures of the front armor to avoid impact on the armor board quick disassembly function after installation.</p>
<b>RFID Interaction Module</b>	Interact with the Function Zone of the Battlefield and realize corresponding functions.
<b>Positioning System Module</b>	Detect a robot’s position on the Battlefield and authorize the robot to connect to the main server.
<b>Main Controller Module</b>	Monitor all referee system modules, send real-time status of a robot to the server wirelessly, and authorize the robot to connect to the main server.



Module	Function
<b>Power Management Module</b>	Control power to the chassis, gimbal, and the launching mechanism, detect the chassis power consumption, and automatically cut off power supply for propulsion when a robot's HP drops to zero.
<b>Camera Video Transmitter Module</b>	Indicate the level of HP with the health bar, and its color is used to distinguish between the red/blue teams and the status of the robot.

Table 4-2 Robot Status in the Monitor Process

Status	Definition
<b>Defense</b>	<p>The Armor Module reduces damage when it is hit or attacked by projectiles.</p> <hr/>  Defense does not apply to blood-deduction penalties caused by violations.
<b>Defeat</b>	HP drops to zero when its Armor Module is attacked, it gets hit, the chassis power consumption exceeds the limit, the projectile initial firing speed exceeds the limit, the referee system goes offline (including ejected by the server).
<b>Slay</b>	<p>A robot attacks the armor module of the enemy's robot till its HP drops to zero.</p> <p>A slain robot can be determined by the following two situations:</p> <ul style="list-style-type: none"> <li>● A robot defeats the enemy's robot with a critical hit.</li> <li>● If a defeated robot has been attacked by one or multiple robots 10s before its death, the last attacking robot is deemed as the killer.</li> </ul>

## 4.2 Level Up

At the start of the competition, the initial Experience Point is zero. Hero and Standard start at Level 1. During a match, one robot can obtain the corresponding Experience Points by slaying an enemy robot (the result is calculated by the referee system server). For example, a robot will directly gain 2.5 Experience Points when slaying a Level 1 Standard.

Hero and Standard can also level up by gaining Experience Points automatically per minute. Standard gains one Experience Point per minute and Hero gains two per minute. If Hero or Standard is defeated, its original Experience Points remains unchanged, but it can no longer obtain automatic gains. After a level up, excessive Experience Points will be counted towards the next level.

After a level up, the barrel heat limit, barrel cooling value, value of Experience Points, current HP, and maximum HP of Hero or Standard will be increased accordingly. Among these, the increase in current HP is the same as the increase in maximum HP. For details, please refer to [Table 3-4](#) and [Table 3-7](#).

## 4.3 HP Deduction

Robot's HP will be deducted if such situation occurs: the barrel heat of the Launching Mechanism exceeds the limit; the initial speed exceeds the limit; the chassis power exceeds the limit; the armor module is hit; important modules go offline; and/or violation of rules.

When the referee system server calculates the HP, it rounds up the decimal point. For example, when an Engineer's Defense is at 80%, the HP deduction is  $2 * (1 - 0.8) = 0.4$ , which rounds up to 0.

### 4.3.1 Barrel Heat

Different types of robots have different initial firing speed limits, heat limits, and cooling values per second according to their function and orientation. For more details, please refer to [3.2.1 Standard](#), [3.2.2 Sentry](#) and [3.2.3 Hero](#).

Set the current barrel heat as  $Q_1$ , the barrel heat limit as  $Q_0$ , the current initial speed as  $V_1$  (m/s), and the initial firing speed limit as  $V_0$  (m/s). Take Standard as an example: the limit for the Standard's initial firing speed is  $V_0 = 30$  m/s, the barrel heat mechanism is as follows:

#### 4.3.1.1 Exceeding the Initial Firing Speed Limit

When  $V_1 > V_0$ , each 17 mm projectile with a speed of  $V_1$  detected by the referee system will cause deduction, and the deducted HP = maximum HP \* L%. For each 42 mm standard projectile detected, the deducted HP = maximum HP \* M%. Values of L% and M% is related to the exceeding range. The larger the exceeding range, the greater the values of L% and M%.

Table 4-3 Penalties for Exceeding the Initial Firing Speed Limit

17 mm Projectile	L%	42 mm Projectile	M%
$0 < V_1 - V_0 < 5$	10%	$V_0 < V_1 \leq 1.1 * V_0$	10%
$5 \leq V_1 - V_0 < 10$	50%	$1.1 * V_0 < V_1 \leq 1.2 * V_0$	20%
$10 \leq V_1 - V_0$	100%	$1.2 * V_0 < V_1$	50%

#### 4.3.1.2 Barrel Heat Exceeds the Limit and Barrel Heat Cooling

For each 17 mm projectile with a speed of  $V_1$  detected by the referee system, the current barrel heat  $Q_1$  is increased by  $V_1$ . For each 42 mm projectile detected, the current barrel heat  $Q_1$  is increased by 100 (regardless of its initial speed). The barrel heat is cooling at a frequency of 10 Hz. The cooling value per detection period = cooling value per second / 10.

It is known that the barrel heat limit is  $Q_0$ ,

- A. When  $Q_1 > Q_0$ , the First Person View (FPV) visibility of the robot operator's computer will be reduced. When  $Q_1 < Q_0$ , the FPV will return to normal. The FPV for the client is as follows:



Figure 4-1 Client FPV

- B. When  $2 * Q_0 > Q_1 > Q_0$ , the deducted HP =  $((Q_1 - Q_0) / 250) / 10 * \text{maximum HP}$  for every 100 ms. The HP will be calculated and cooled after deduction.
- C. When  $Q_1 \geq 2Q_0$ , the deducted HP =  $(Q_1 - 2 * Q_0) / 250 * \text{maximum HP}$ . After deducting HP, set  $Q_1 = 2Q_0$ .

**HP deduction logic when the barrel heat exceeds the limit and barrel heat cooling logic:**

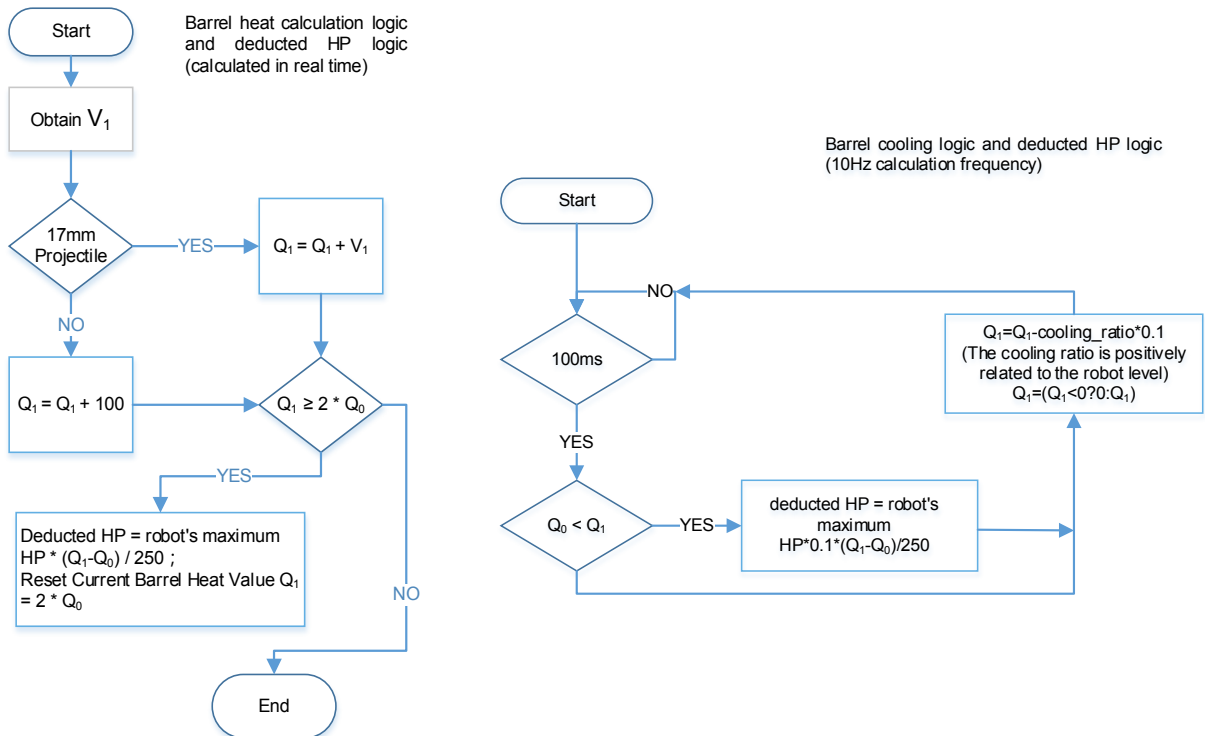

Figure 4-2 HP Deduction Logic When the Barrel Heat Exceeds the Limit (left) and Barrel Heat Cooling Logic (right)

## 4.3.2 Chassis Power Consumption

Different types of robots have the corresponding chassis power consumption limit according to their function and orientation.

Table 4-4 Robot Chassis Power Consumption Limit

Type	Power Consumption Limit (watts)
Standard	80
Hero	80
Sentry	20
Aerial	No limit
Engineer	No limit



- Robot's chassis: a mechanism that carries and installs the robot propulsion system and its accessories.
- Chassis power consumption: the power that enables the robot to move horizontally, excluding power used for special tasks (such as the power consumption for functional movements like moving the upper mechanical structure).

### Pre-match Inspection Requirement

Standard or Hero faces and abuts the vertical rigid plane (such as the wall), the remote controller pushes to the maximum rod amount, the robot accelerates for 20 seconds, and there is no blood-deduction due to exceeding the limit throughout the whole process. There are no requirements for sentry robots.

Violations and Penalties:

Robots that do not meet the requirements cannot pass the pre-match inspection.

### Chassis Power Consumption Exceeds the Limit

The chassis power consumption of the robot will be continuously monitored by the referee system. The system monitors the chassis power consumption at a frequency of 10Hz and triggers penalties when the power consumption exceeds the limit. Different types of robots trigger different penalties. Considering that it is difficult to control instantaneous output power when the robot is in motion, the competition defines a buffer energy (W) on the referee system server. The buffer energy (W) of Standard or Hero is 60J while that of Sentry is 200 J.

Ratio of exceeding the limit:  $K = (Pr - PI) / PI$ , where  $Pr$  is the instantaneous chassis output power consumption and  $PI$  is the power consumption limit.

Table 4-5 Penalties for Chassis Power Consumption Exceeds the Limit

K	N%
$K \leq 10\%$	10%
$10\% < K \leq 20\%$	20%
$K > 20\%$	40%

**Standard or Hero:**

When a Standard's or a Hero's chassis power consumption exceeds the limit, the deducted HP = maximum HP \* N%.

For example, if the robot has a continuous power output of 140 W, 60 J of energy will be consumed after one second. In the next 100 ms detection period, the calculated overrun ratio  $K = (140-80) / 80 = 75\%$ . Since  $K > 20\%$ , the deducted HP =  $300 * 40\% * 0.1 = 12$ .

The logic diagram of chassis power consumption detection and HP deduction of Standard or Hero is shown below:

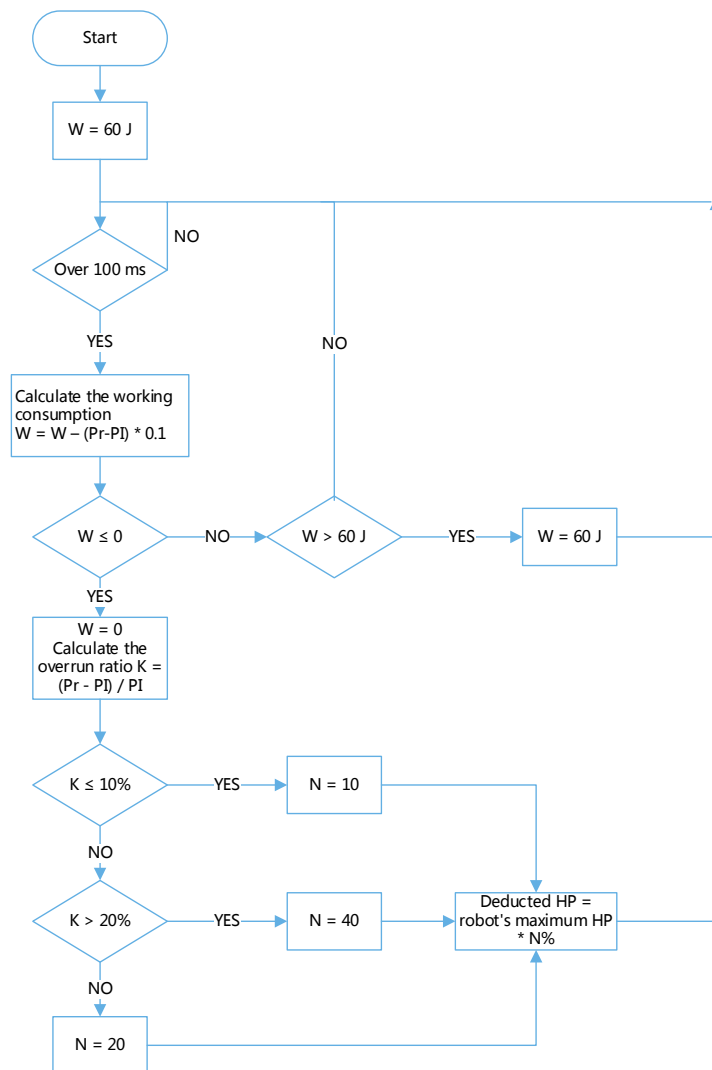

Figure 4-3 Chassis Power Consumption Detection and HP Deduction

## Sentry:

When a Sentry's chassis power consumption exceeds the limit, its chassis will be powered off.

The logic diagram of chassis power consumption detection and chassis powering off of Sentry is shown below:

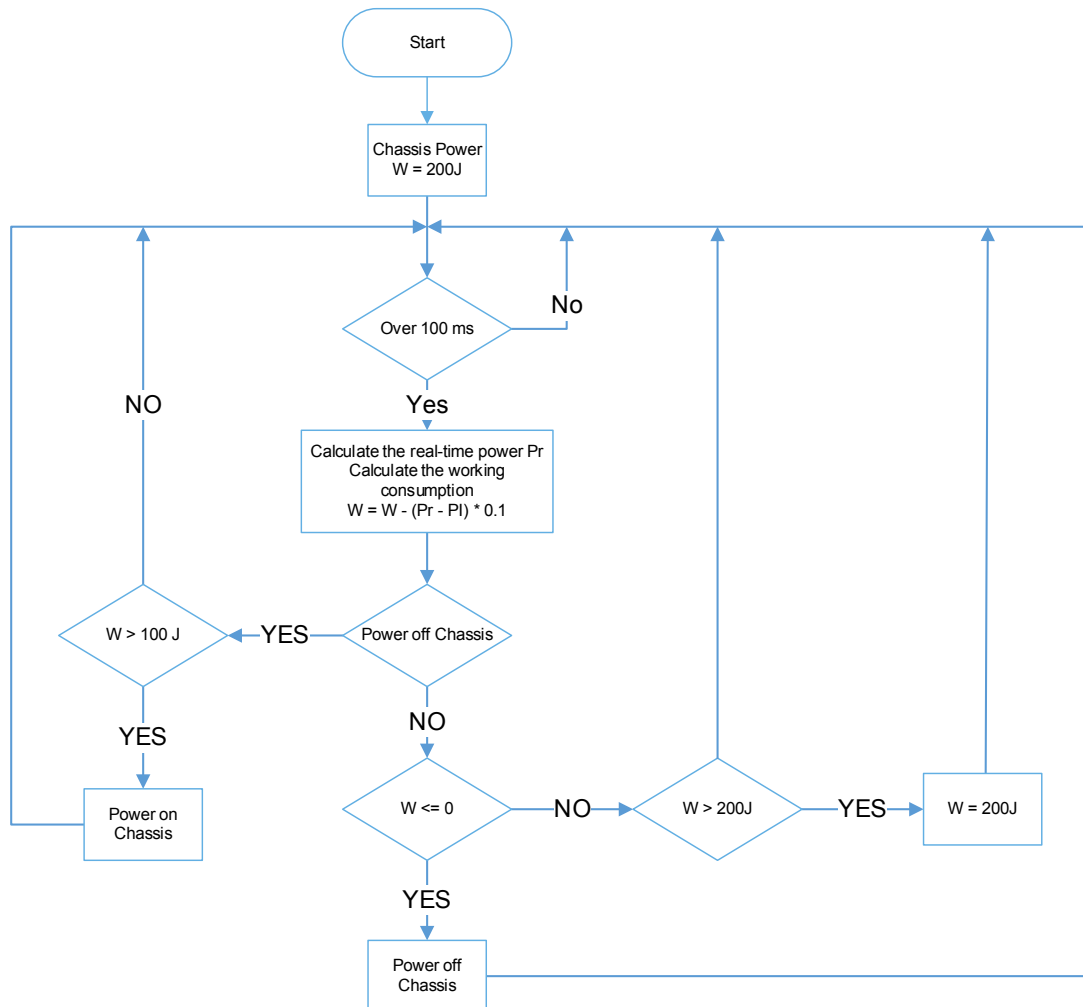

Figure 4-4 Chassis Power Consumption Detection and Chassis Powering Off

### 4.3.3 Armor Attack

The Armor Module detects damage sources based on its pressure sensor feedback and the vibration frequency of the armor plate. Damage sources are divided into projectile attack and collision. Projectile is the only legal damage source. Collisions including crashing into other robots, throwing objects or robot's components hitting against the Battlefield are prohibited. For penalties, please refer to [6.5.4.2 Collision and Getting Stuck Together](#).

The highest frequency which the armor module can detect during a detection period of 50 ms is 20 Hz. When a 17 mm projectile and 42 mm projectile come into contact with the large Armor Module at speeds

of 12 m/s and 8 m/s respectively, they can be effectively detected. The triangle Armor Module at the top of the Base can only detect 42 mm projectile. When a 42 mm projectile comes into contact with the triangle Armor Module at speed of 6 m/s, it can be effectively detected.

Below is the HP deduction under the situation of no attack gain.

Table 4-6 HP Deduction of Armor Attack

Attack Type	HP Deduction
42 mm projectile	100
17 mm projectile	10
Collision	2



Please note that the actual HP Deduction may vary with the actual firing speed and firing distance, and the results are subject to the determination of the Referee System.

The damage of 42 mm projectile that is detected by the triangle Armor Module at the top of the Base is twice the large Armor Module. For example, under the situation that there is no attack gain and that the Base is defenseless, when Hero shoots 42 mm projectile to the top triangular Armor Module of the Base, the Base HP is deducted by 200.

### 4.3.4 Referee System Going Offline

Install referee systems of the corresponding modules as required in the [RoboMaster 2019 Robotics Competition Referee System Specification Manual](#). During the competition, the connection between each module and the server must be stable. The referee system server detects the connectivity of each module at a frequency of 2 Hz. If important modules, which are speed monitor module, positioning system module and armor module, go offline due to problems of design or structure, then a certain amount of HP will be deducted.

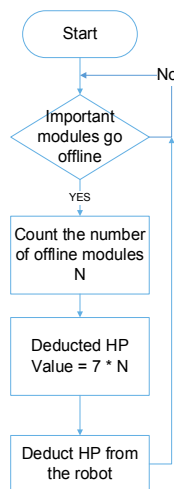
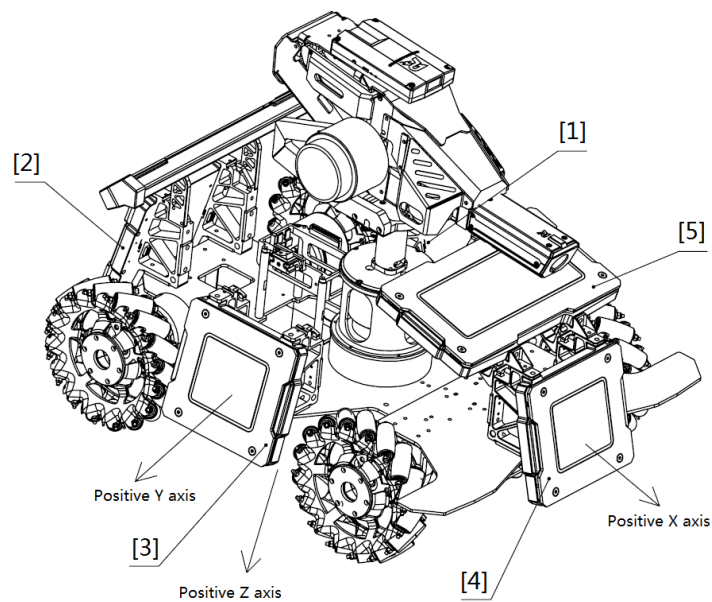

Figure 4-5 HP Deduction Mechanism of Referee System Important Module Going Offline

The Armor Module must be configured with the correct ID number before the pre-match inspection. The specific requirements are as follows:

### Standard and Hero

According to the Robot Coordinate System established by the armor module installation requirements, set the armor module ID of the Positive X axis as 0, the Negative Y axis as 1, the Negative X axis as 2, the Positive Y axis as 3 and the Negative Z axis as 4. In other words, after entering the armor ID setting mode, tap the Positive X axis, the Negative Y axis, the Negative X axis, the Positive Y axis, and the Negative Z axis in turn to complete ID settings.



[1] Armor #1 [2] Armor #2 [3] Armor #3

[4] Armor #0 [5] Armor #4 - -

Figure 4-6 Standard and Hero Armor Module ID Setting

Teams must set the Armor Module ID according to the above specification, so that the attack direction can be displayed accurately on the operator's operation page and at the same time, the correctness of the “real-time HP change information” produced by the Referee System can be guaranteed.

### Engineer

Engineer has four pieces of armor. If a competition starts with an Engineer, the Video Transmitter Module faces towards the Positive X axis of the Robot Coordinate System. The Armor Module ID of the Positive X axis is set as 0, the Positive Y axis as 1, the Negative X axis as 2, the Negative Y axis as 3.

### Sentry

Sentry has two pieces of Armor Module, the ID of the one facing the Base Zone is 0, and the other is 1.



## 4.4 HP Recovery and Revival

- **Qualification:** Only Standard, Hero and Engineer are eligible for HP recovery and revival. A robot that is ejected due to a Level 4 Warning is not eligible for revival.
- **Revival mechanism:** Robot(s) from one team can transport a defeated robot to the Restoration Zone of its own Supplier Zone. When the defeated robot detects the RFID Interaction Module of the Restoration Zone, it will be revived after a certain period. After revival, the Level and Experience Points of the robot before it was defeated are maintained, and the HP is restored to 20% of the maximum HP. The robot is on the 100% defensive within 10 seconds after revival. For the definition of defense, please refer to [Table 4-2](#).
- **Required detection time for revival:** For robots defeated for the first time, they are revived in T seconds after their RFID Interaction Module detects that of the Restoration Zone. After that, the detection time is increased by 10 seconds following each revival. Calculate the number of resurrections and the required detection time separately for each robot.

Table 4-7 First Revival Time for Different Types of Robot

Type	T Second(s)
Standard	5
Hero	10
Engineer	20

- **HP recovery mechanism:** When a surviving robot is at its own Restoration Zone and detects the RFID Interaction Module of the Zone, it will recover HP at an amount equal to 5% of its maximum HP per second until its HP is fully restored.

# 5. Competition Area

## 5.1 Overview



The error margin of all Battlefield Components described in the chapter is within  $\pm 5\%$  and the dimension unit is mm.

The core Competition Area of RoboMaster 2019 Robotics Competition is called the “Battlefield”. It is 28 meters long and 15 meters wide, and consists of Starting Zone, Supplier Zone, Bridge, Open Zone, Resource Island and Flight Zone.

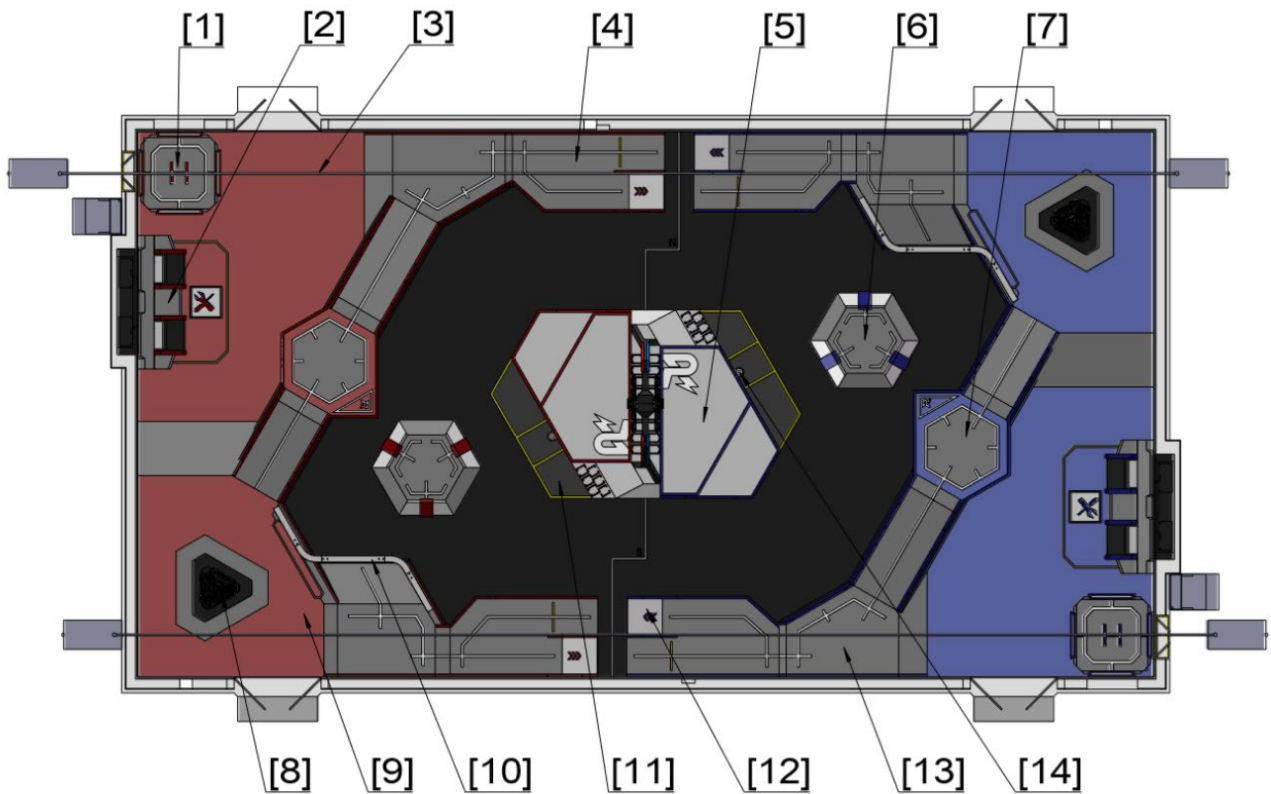

- |                          |                      |                                   |               |
|--------------------------|----------------------|-----------------------------------|---------------|
| [1] Landing Pad          | [2] Supplier Zone    | [3] Aerial Safety Rope            | [4] Road      |
| [5] Resource Island      | [6] Bunker           | [7] Bridge Top Platform           | [8] Base Zone |
| [9] Starting Zone        | [10] Sentry Rail     | [11] Resource Island Penalty Zone | [12] Sope     |
| [13] Bridge End Platform | [14] Assisive Column |                                   |               |

Figure 5-1 Battlefield Top View

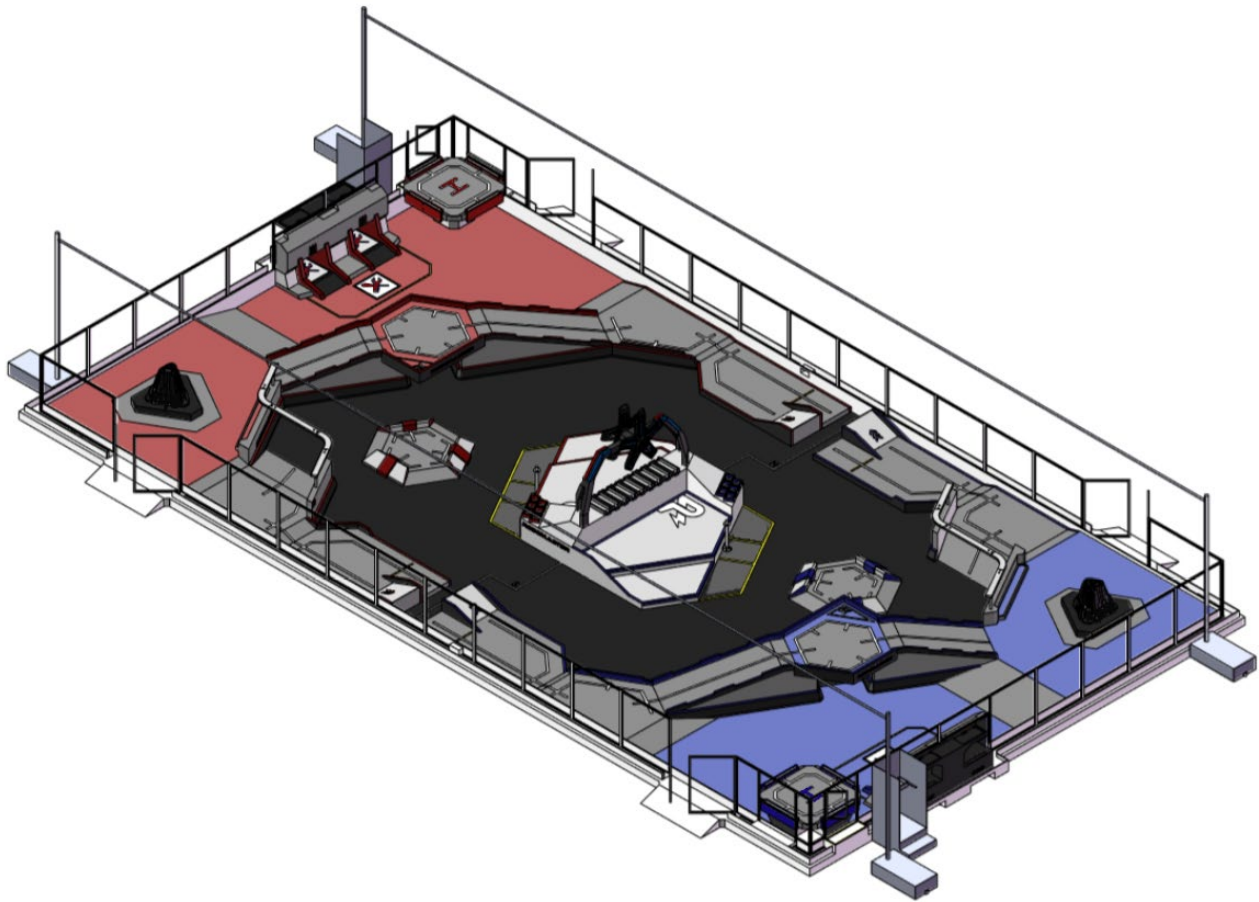

Figure 5-2 Battlefield Axonometric Drawing

The Battlefield and the Bunker are laid with sand-grained rubber with a thickness of 3 mm. Part of the surface of the Bunker is covered with paint and the rubber substance is made of PVC. The reference picture is as follows:



Figure 5-3 Rubber Reference Drawing

## 5.2 Starting Zone

The Starting Zone is the area where the ground robots are placed before the official start of the match,

including the Base Zone, Sentry Rail and Base. The area where the red ground rubber is laid in the figure below is the Starting Zone of the red team (the blue team's Starting Zone is at the same position on the other side of the Battlefield).

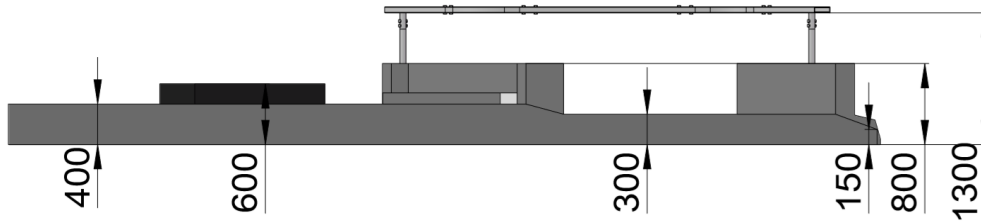
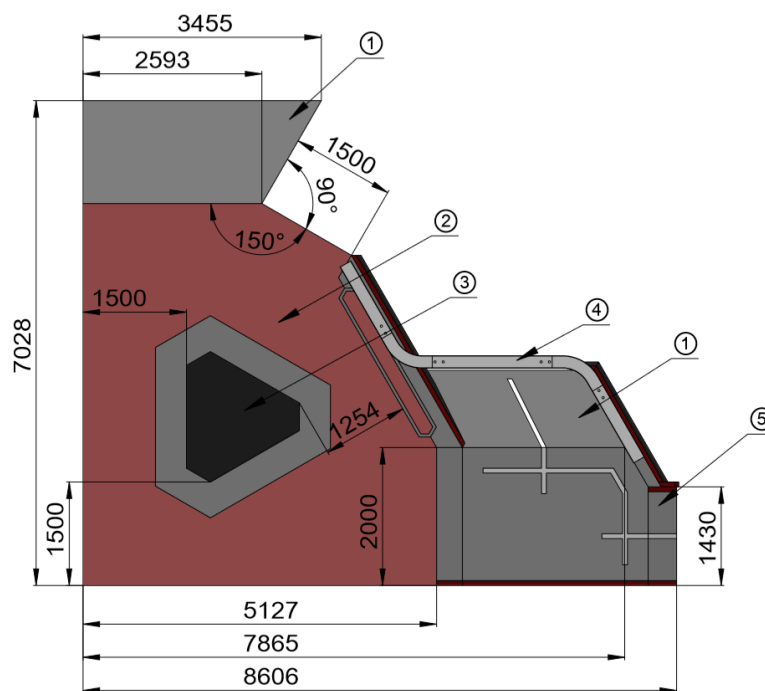

Figure 5-4 Starting Zone Front View



- [1] 15° Slope
- [2] Starting Zone
- [3] Base Zone
- [4] Sentry Rail
- [5] 20° Slope

Figure 5-5 Starting Zone Top View

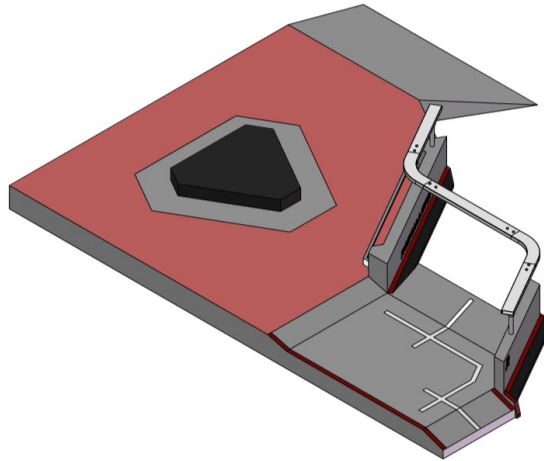

Figure 5-6 Starting Zone Axonometric Drawing

### 5.2.1 Base Zone

The Base Zone is a hexagonal platform located on top of the Starting Zone. Its top surface is 200 mm higher than that of the Starting Zone. One fixed Base is placed on top of the Base Zone.

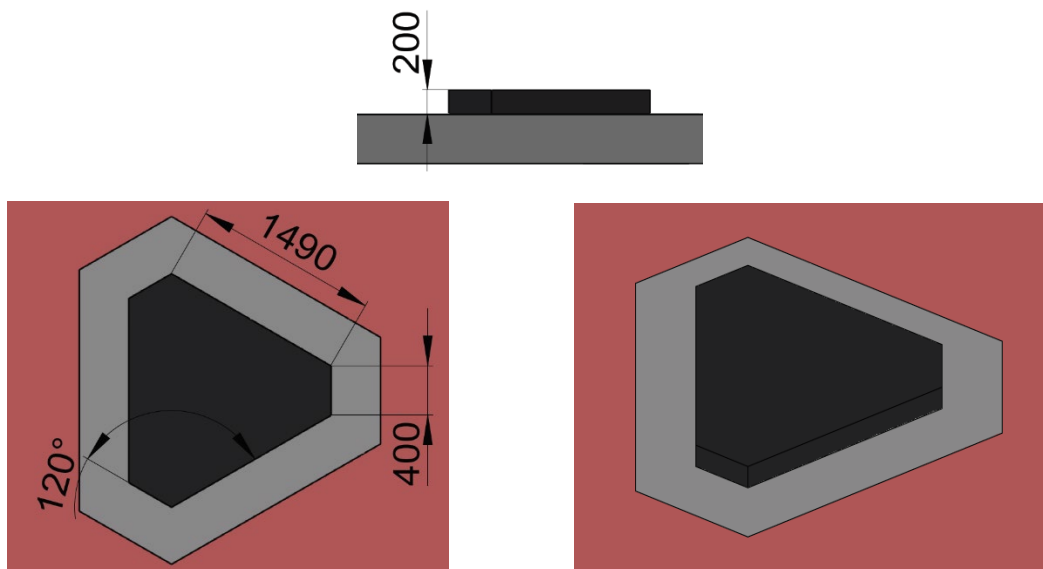

Figure 5-7 Base

The Base Zone platform and the space above are Penalty Zones for robots of both teams. Robots of either side are not allowed to enter the Penalty Zone.

#### Violations and Penalties:

- If any part of a robot enters the Base Zone for  $T$  second(s), the referee will issue a Level X Warning and the violator must leave the Base Zone.

T second(s)	Level X Warning
$T < 3$	1
$3 < T < 10$	2

- If damages that affect the fairness of the competition occur, e.g. a robot causes damage to the Base structure and it no longer operates, or an ejected robot remains at the Base Penalty Zone and leads to the problem that the Base cannot open, the referee will issue a Level 5 Warning to the violator. The actual situation shall be determined by the Head Referee and the Chief Referee.

## 5.2.2 Sentry Rail

The Sentry Rail consists of the main rail and its supporting frame. The main rail is the only place on which a Sentry moves. The distance between the lower surface of the Sentry Rail and the Battlefield ground is 1300 mm in theory. However, due to the weight of the rail itself and other factors, there is a certain height difference between the middle and the ends of the Sentry Rail. Therefore, the actual distance is 1250-1300 mm. The surface of the Sentry Rail is matte paint.

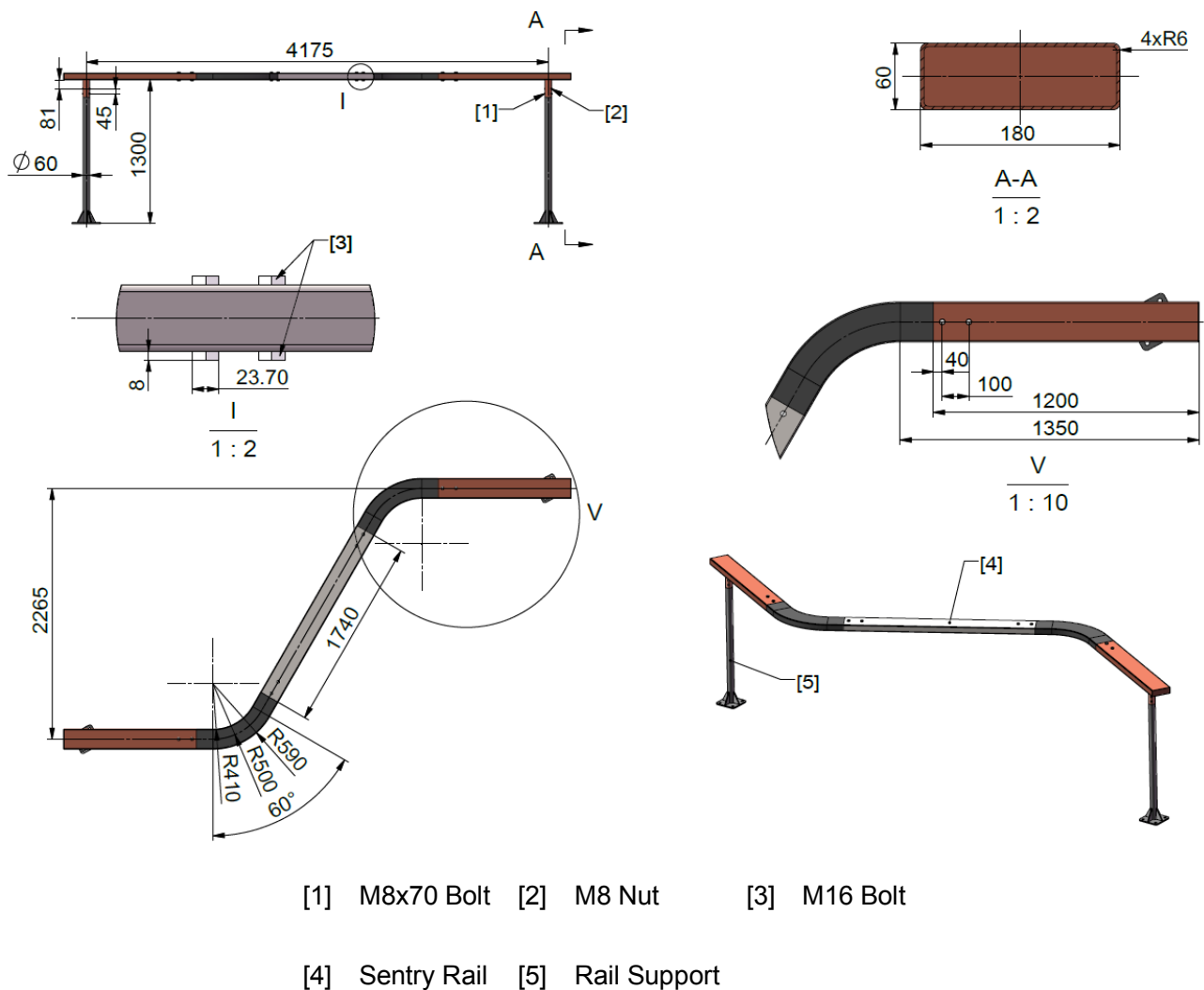

Figure 5-8 Sentry Rail



- Each color in the diagram represents one component.
- Parts are connected by bolts.
- The flat tubes and round tubes of each part are welded together.
- Flat tubes are formed by folding the three corners, and the final corner is welded shut.
- The angle of the hexagonal bolt head after tightening is uncertain. The drawing is for reference only.

### 5.2.3 Base

Each team has a Base of 2000 HP in total. On the top of the Base, there are three large Armor Modules and one triangular Armor Module. In the middle of the interior, there are three large Armor Modules with the corresponding No.8 sticker attached. For details, please refer to [Appendix 6 Reference Drawing](#). For information about HP deduction when the Armor Modules of the Base has been attacked, please refer to [4.3.3 Armor Attack](#). For the relationship between Sentry and the Base shield, please refer to [3.2.2 Sentry](#). For Base exception treatment, please refer to [6.5.4.5 Exception Handling](#).

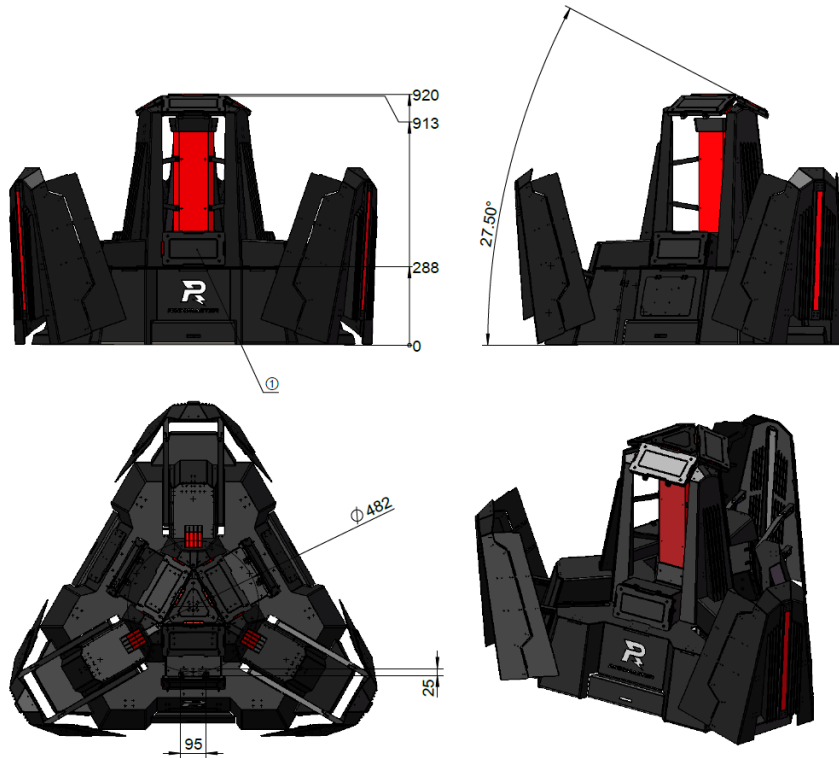

[1] Intersection angle between the large armor panel inside the base with the ground is 75°

Figure 5-9 Open Base Shield

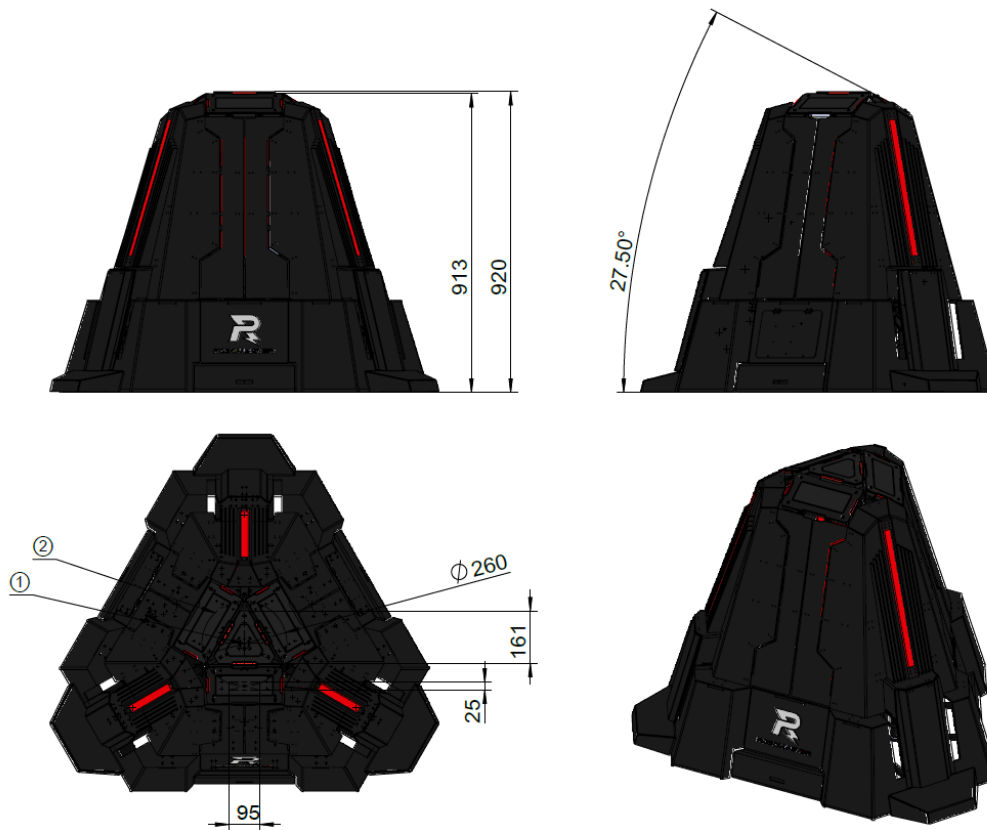

[1] Triangle Armor Module [2] Large Armor Module

Figure 5-10 Close Base Shield

### 5.3 Supplier Zone

Supplier Zone is an important area for robots to reload projectiles, revive defeated robots and recover HP. Each team has one Supplier Zone which consists of three Restoration Zones and two Project Outlets. Engineer is forbidden to go to the Supplier Zone for projectiles.





Since the Projectile Outlet is large, teams are recommended to enlarge the robot's Projectile Loading Port to prevent projectiles falling to the ground during reloading, and to use buffer materials as the internal wall of the Projectile Depot to avoid loss.

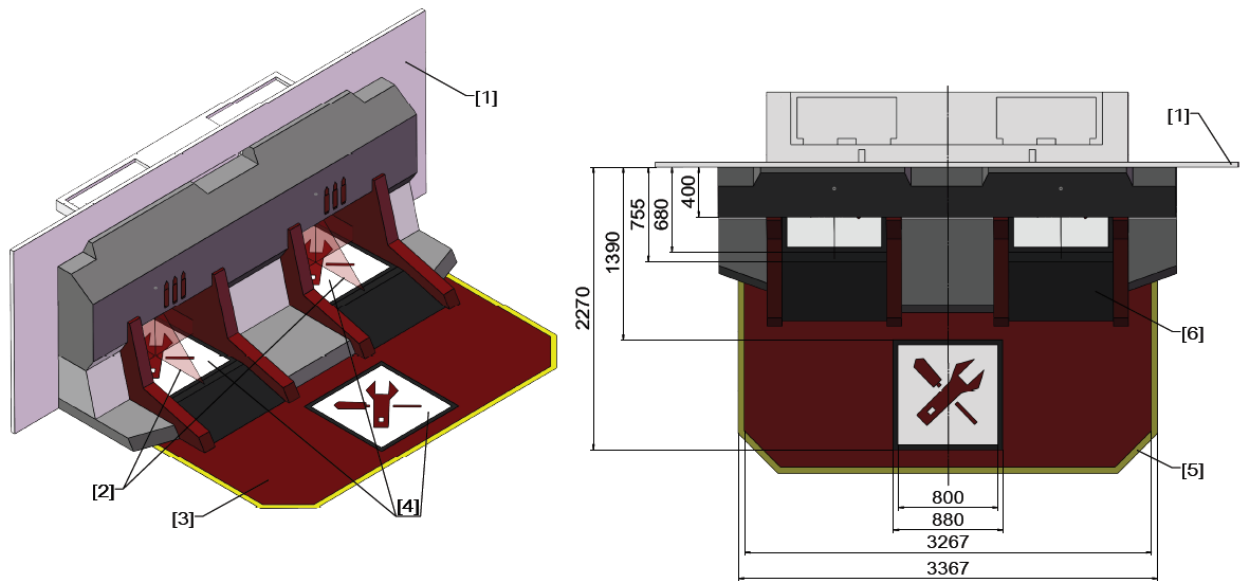

- [1] Perimeter Wall    [2] Laser Light Path    [3] Ground  
[4] Restoration Zone    [5] Supplier Penalty Zone    [6] 15° Slope

Figure 5-11 Supplier Zone

### 5.3.1 Restoration Zone

There are three Restoration Zones in the Supplier Zone, one 800\*800 mm and two 1100\*800 mm, and they are laid with several RFID Interaction Modules. Mark of Restoration Zone is shown above. When ground robots detect the RFID Interaction Modules of the Restoration Zone, defeated robots can be revived and surviving robots recover HP simultaneously. For specific implementations and values, please refer to [4.4 HP Recovery and Revival](#).

### 5.3.2 Projectile Supplier

Projectile Supplier provides 17 mm standard projectiles during a match and consists of two Projectile Outlets, an auxiliary alignment laser sight, a camera and a monitor. Each team has its own Projectile Supplier. At the beginning of each match, Projectile Supplier will issue 200 shoots of 17 mm projectiles, and then 150 shoots per minute.

Projectile Supplier is directly controlled by the Operator from the Operator Room on the operation interface. When a match starts, the operator controls the robot and moves it toward the lower area of the projectile falling ports for the official projectile supplier. Then the camera will capture the robot magazine in real time and display it on the front monitor. The operator can adjust the position of the robot through the laser projected by the cross laser light. This allows the operator to determine whether or not to supply

projectiles. When the time comes to perform the replenishment action, press the 'O' key on the keyboard. If, at this time, there are remaining projectiles on the robot's own side and the robot successfully senses the site interaction module card below the supplier zone, you can directly select the number of ammunition replenishments in the replenishment panel to complete the ammunition replenishment action; if the robot fails to successfully sense the site interaction module card below the replenishment zone, the ammunition replenishment action can be forced using the 'forced ammunition replenishment' prompt command.



Cross laser light: formed by two horizontal laser light intersected at the circle center of the Projectile Outlet.

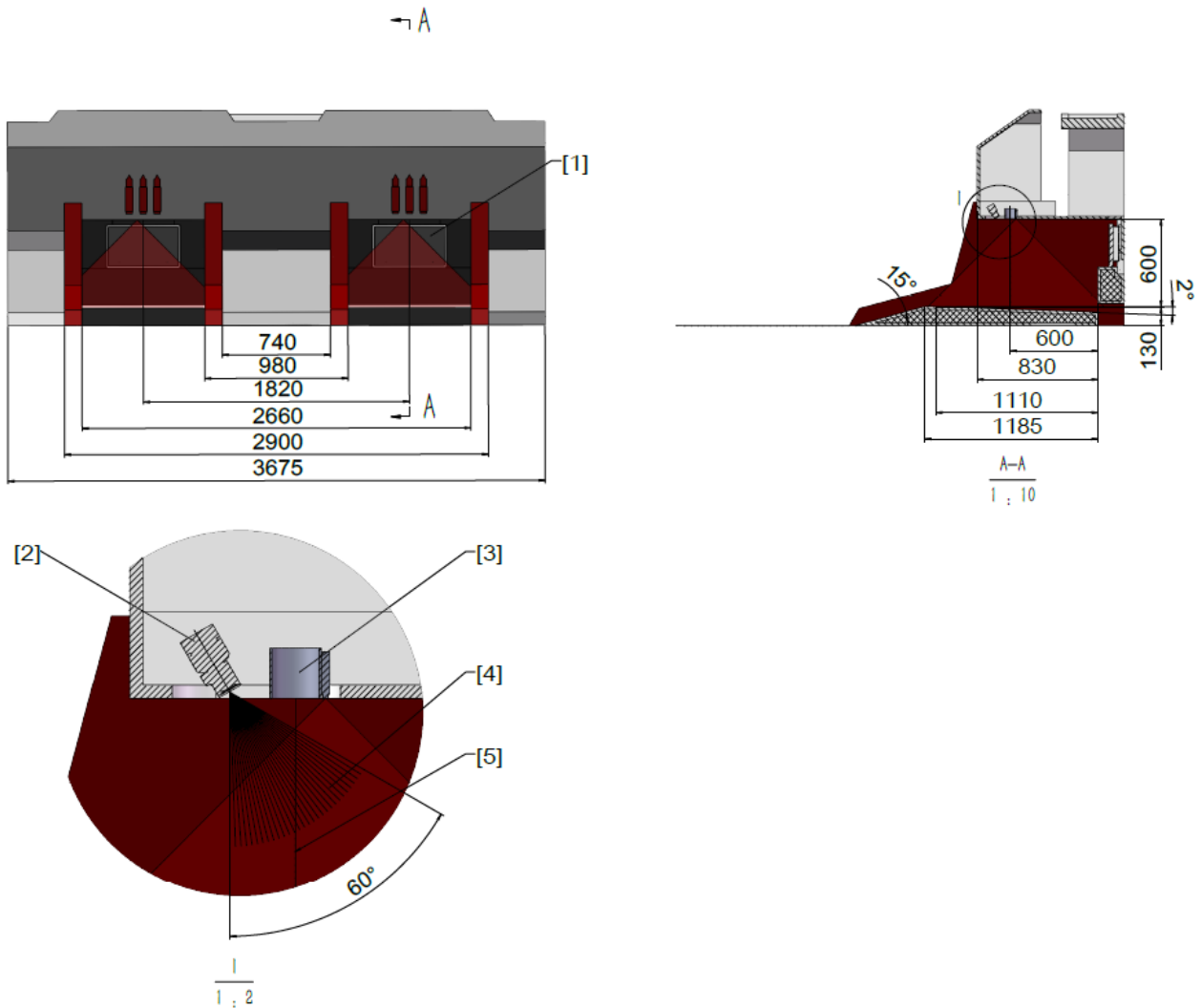

- |                             |                                 |                       |
|-----------------------------|---------------------------------|-----------------------|
| [1] 21" Monitor             | [2] Camera                      | [3] Projectile Outlet |
| [4] Camera View-angle Range | [5] Horizontal Laser Light Path |                       |

Figure 5-12 Projectile Supplier

## 5.4 Supplier Penalty Zone

The Supplier Zone of one team is the Penalty Zone to the other. As shown above, the internal and above space of the yellow frame with the largest outside dimensions of 3368 \* 2495 is the Penalty Zone. Robot cannot enter into the opposing team's Supplier Zone and place Projectile Containers in the Penalty Zone.

Violations and Penalties:

- If any part of a robot enters or flies above the opposing team's Supplier Zone for less than three seconds, the referee will issue a Level 1 Warning.
- If any part of a robot enters or flies above the opposing team's Supplier Zone for 3-10 seconds, or makes physical contact with Projectile Suppliers, the referee will issue a Level 2 Warning, and the robot must immediately leave the opposing team's Supplier Zone.
- If any part of a robot enters or flies above the opposing team's Supplier Zone for 3-10 seconds and makes physical contact with Projectile Suppliers, or disturbs the normal projectile loading, recovery or revival of the enemy's robots, the referee will issue a Level 3 Warning, and the robot must immediately leave the opposing team's Supplier Zone.
- If any part of a robot enters or flies above the opposing team's Supplier Zone for more than 10 seconds and makes physical contact with Projectile Suppliers, or causes the enemy's robots unable to supply projectiles, the referee will issue a Level 4 Warning. The actual situation shall be determined by the Head Referee and the Chief Referee.
- If a robot causes structure damage to the opposing team's Projectile Supplier which can no longer provide projectiles, or place Projectile Containers in the Penalty Zone or if the ejected robot remains at the opposing team's Supplier Zone or the above space, causing robots of the team unable to obtain projectiles, the referee will issue a Level 5 Warning. The actual situation will be determined by the Head Referee and the Chief Referee.

## 5.5 Open Zone

As the center of the Battlefield, Open Zone is an important and the most intense area for fighting. This area consists of Resource Island and Bunker Zone, as well as other core gear and components such as Power Rune, Assistive Column, Projectile Container, Projectile Depot and Bunker.

### 5.5.1 Bridge

Bridge is a core channel that connects the Open Zone and the Starting Zone, which is the shortcut for entering into the enemy's Starting Zone, including the Bridge Top Platform and Bridge End Platform.

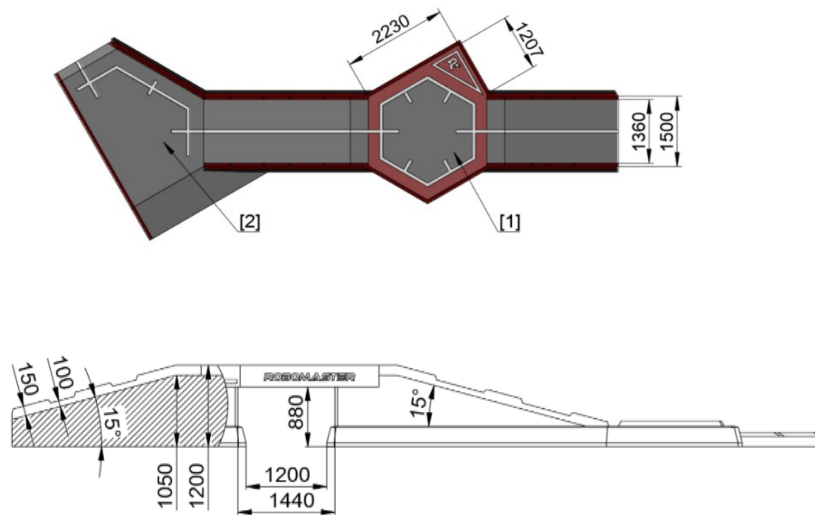

[1] Bridge Top Platform [2] Bridge End Platform

Figure 5-13 Bridge

### Bridge Top Platform:

The top surface of the Bridge is Bridge Top Platform, which is laid with two kinds of RFID Interaction Module cards, one is distributed inside the blue frame as shown below and the other is in the green frame.

- If the robot reaches the blue frame area of its own side and stays for 3 seconds, the robot's barrel heat will be reduced 5 times faster per second. If the robot leaves the blue frame area of its side for more than two seconds, the gain will be invalid.
- Four minutes after the start of the game, if the robot reaches the green frame area of its own side and stays for 3 seconds, the Power Rune on the Resource Island enters an activating state (see [Figure 5-33](#)) and the robot's barrel heat will be reduced five times faster than before occupying the Bridge Top Platform. If one side's Power Rune preferentially enters the activated state (see [Figure 5-35](#)), the other side's Power Rune cannot continue to be activated. If the robot leaves the green frame area of its own side for more than two seconds, the gain in barrel heat per second of cooling value will be invalid.

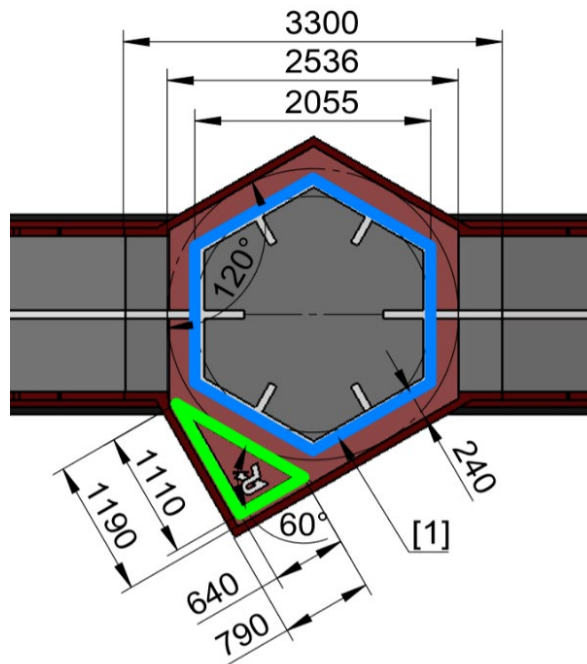

[1] RFID Interaction Module cards are laid inside the blue frame (same goes for green frame)

Figure 5-14 Bridge Top Platform



Figure 5-15 Position Relation between the Bridge Top Platform and Power Rune

### Bridge End Platform:

Bridge End Platform is located at the end of the Bridge with strategic importance and laid with several RFID interaction module cards. When a robot occupies the Bridge End Platform, its barrel cooling value per second is five times faster than normal. Only robots of the first occupied team can gain this bonus. If the robot leaves the blue frame area for more than two seconds, the gain will be invalid.

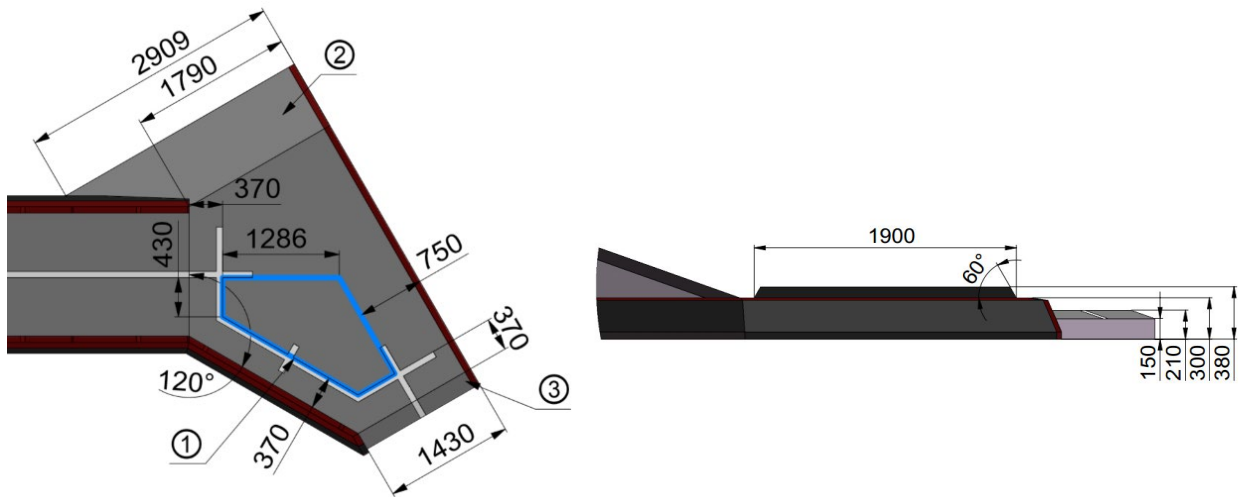

- ① RFID Interaction Module cards are laid inside the blue frame ② 15° Slope ③ 17° Slope

Figure 5-16 Bridge End Platform

### 5.5.2 Bunker

The Open Zone contains two Bunkers: one sets barrel heat cooling value and the other sets defense bonus gain effect. When a robot occupies a Bunker, it receives a 50% defense bonus and the barrel heat cooling value is five times faster than normal. Only robots of the first occupied team can gain this bonus. If the robot leaves the blue frame area for more than two seconds, the gain will be invalid.

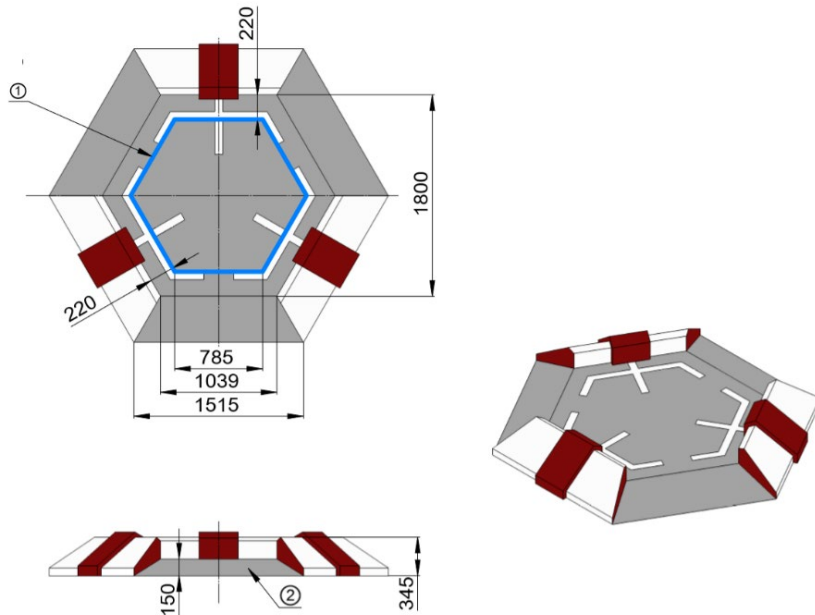

- ① RFID Interaction Module cards laid inside the blue frame ② 20° Slope

Figure 5-17 Bunker

### 5.5.3 Road

Road in the Open Zone connects one side of the Bridge End Platform with the other side of the Starting

Zone. There is a gully of 650 mm in the middle of the Road.

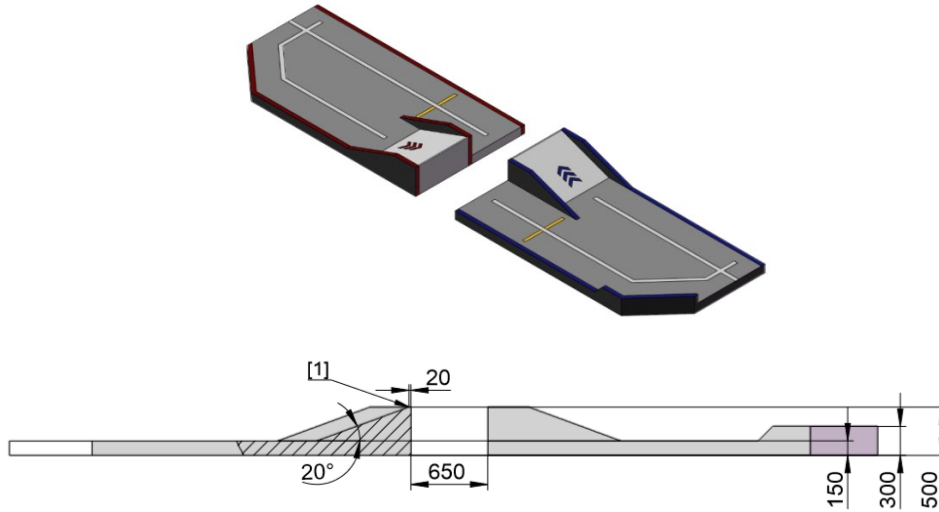

[1] Right angle corners are fitted with aluminum corner guards

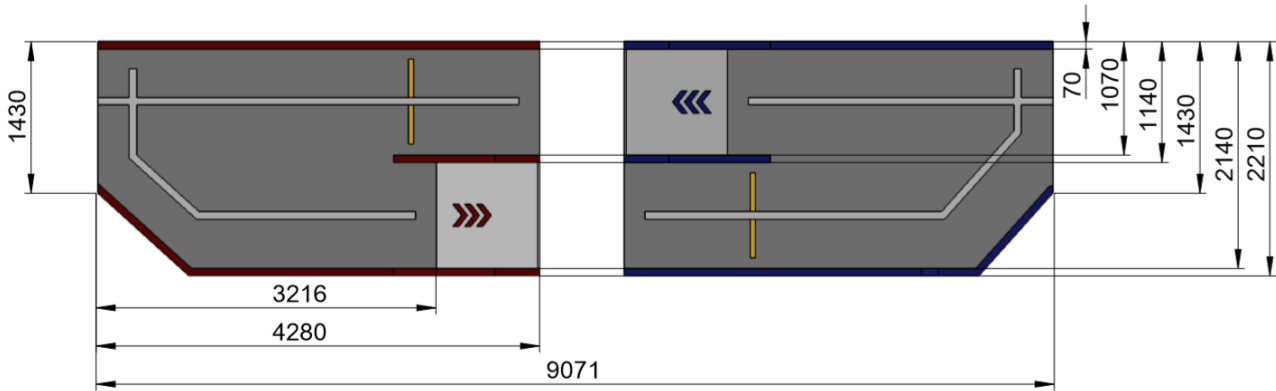

Figure 5-18 Road

### Road Penalty Zone

Road Penalty Zone refers to the area of 1200\*1070, which is the blue box area shown in the figure below. EVA rubber foaming material is placed in this area. Robots of either side shall not enter Road Penalty Zone and the robot shall not place the Projectile Container in the Zone.

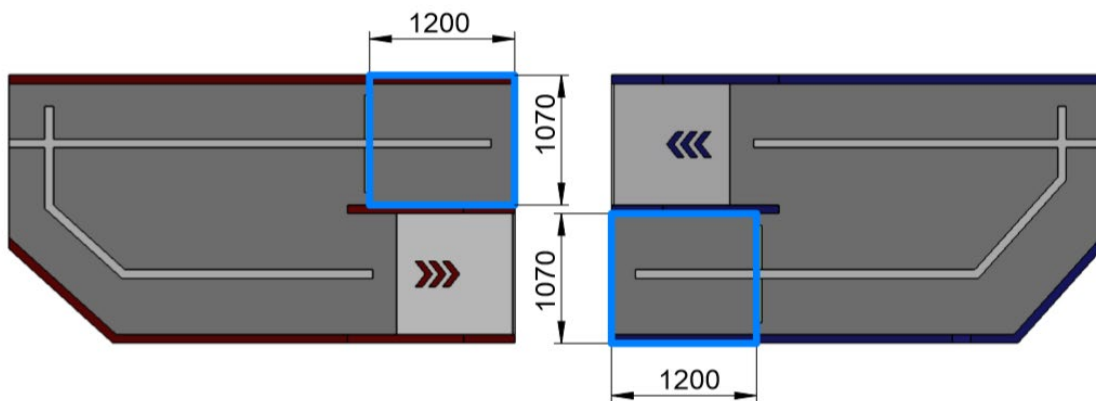

Figure 5-19 Road Penalty Zone

## Violations and Penalties:

- Once any part of the robot stays temporarily (less than 3 seconds) in Road Penalty Zone, the referee will give the violating party a Level 1 Warning.
- Once any part of a robot has been in Road Penalty Zone for a moderately long period of time (more than 3 seconds, less than 10 seconds), the referee will give the offending party a Level 2 Warning and the robot must exit Road Penalty Zone.
- Once any part of the robot stays in Road Penalty Zone for a severely long period of time (more than 10 seconds), the referee will give the violating party a Level 3 Warning. The actual situation shall be judged by the Head Referee and the Chief Referee.
- Once a robot of either side stays in Road Penalty Zone or a gully in the road, and the other side's robot makes a serious collision and damages its structure when it makes a leap, then the violating party is responsible for it. If the other side's robot has serious structural damage, the offending party will be directly judged to have failed. The actual situation shall be judged by the Chief Referee.

## 5.6 Resource Island

Located in the middle of the Battlefield, Resource Island is an irregular hexagonal platform and consists of Projectile Container, Power Rune, and Assistive Column. Engineer of both teams are allowed to obtain Projectile Containers from the Resource Island.

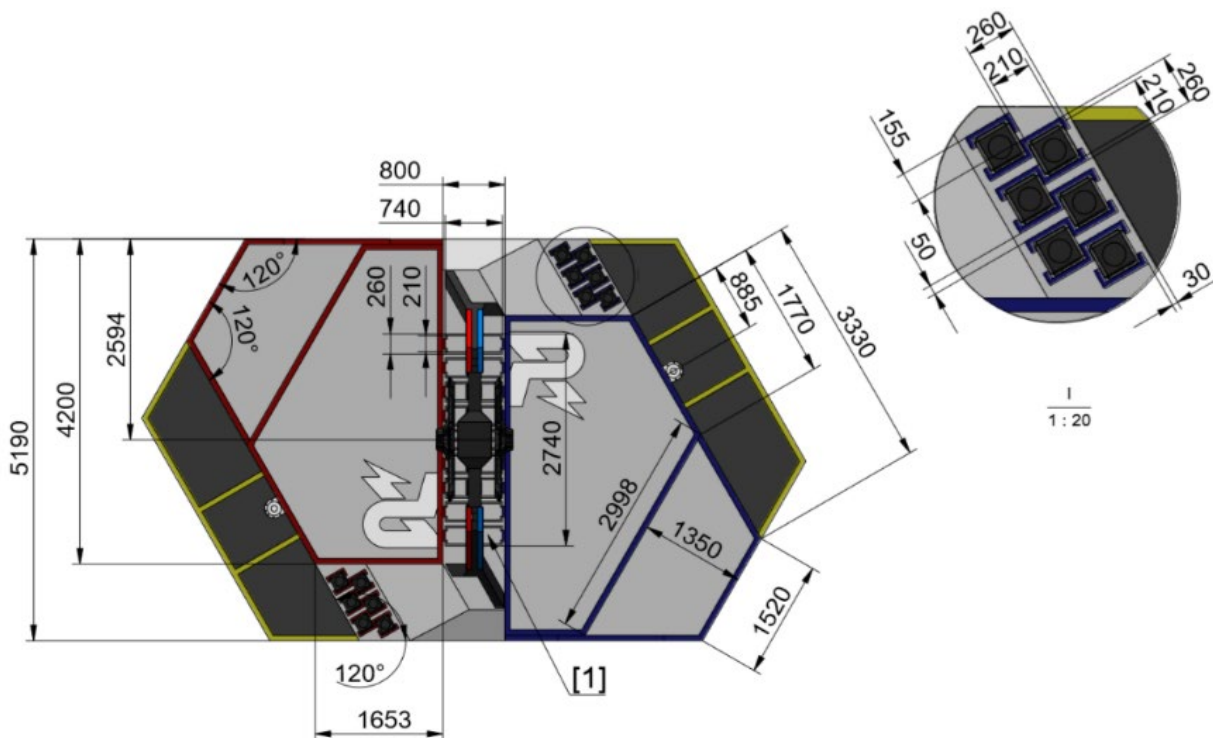

[1] Projectile Containers are placed at the center of each groove

Figure 5-20 Resource Island Top View



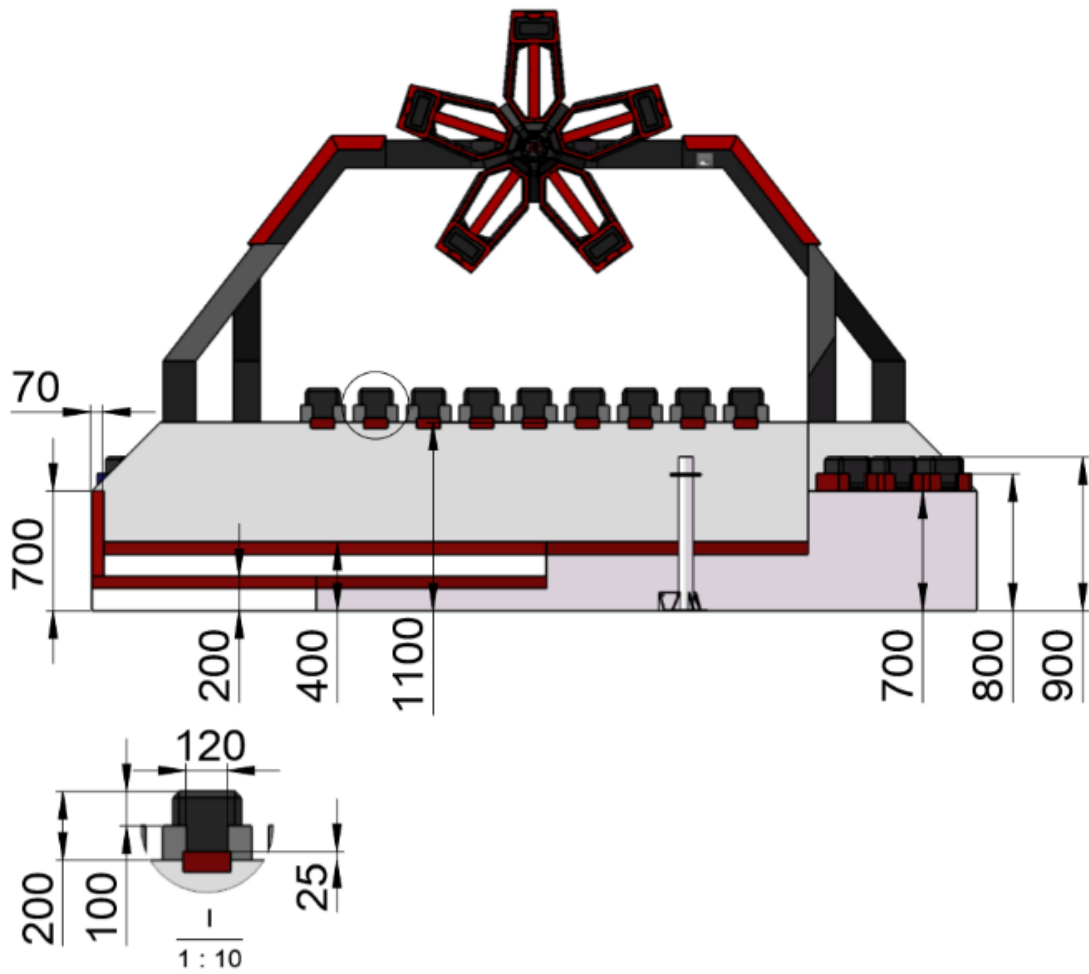

Figure 5-21 Resource Island Front View

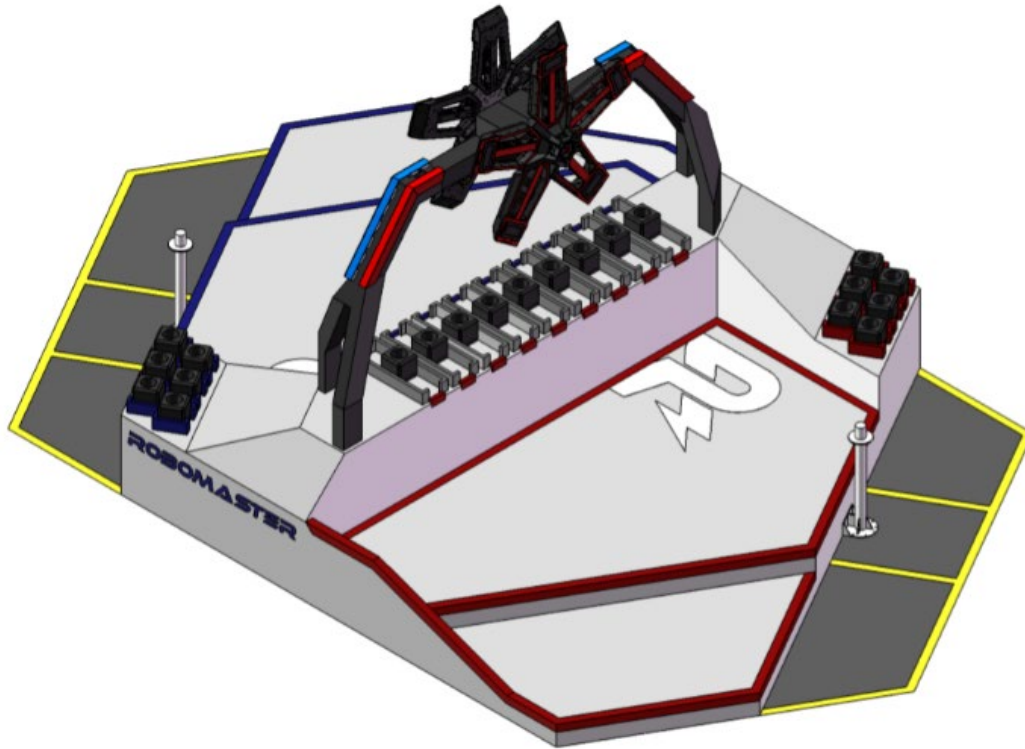
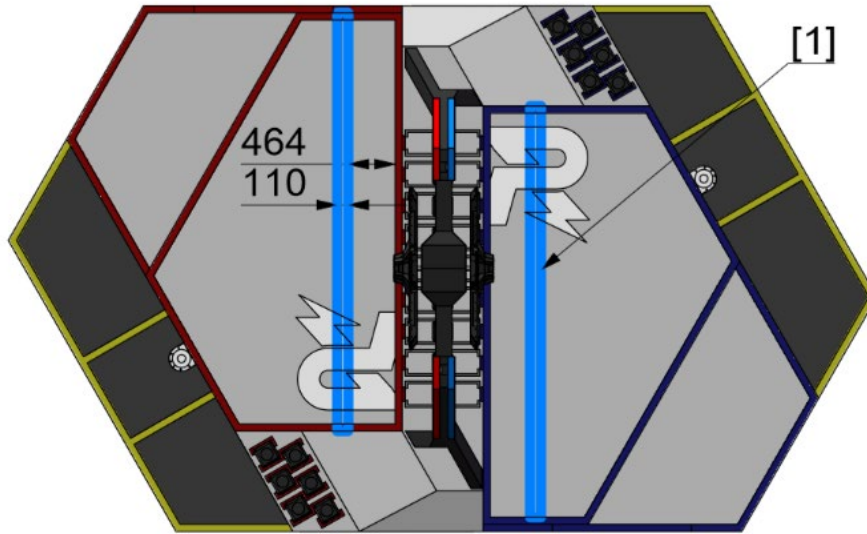

Figure 5-22 Resource Island Axonometric Drawing

There is a row of RFID Interaction Modules located along the edges of the Resource Island. Since these

cards boast defense function and can be called “Defense Card”. When Engineer detects this defense card, it receives a 80% defense for 20 seconds.



[1] RFID Interaction Module cards laid inside the blue frame

Figure 5-23 Resource Island

### 5.6.1 Resource Island Penalty Zone

The shape of Resource Island Penalty Zone is an irregular polygon, indicated by a yellow frame that outlines the Resource Island as shown below. In the Resource Island Penalty Zone, Engineer has priority and can stay in it for a long time.

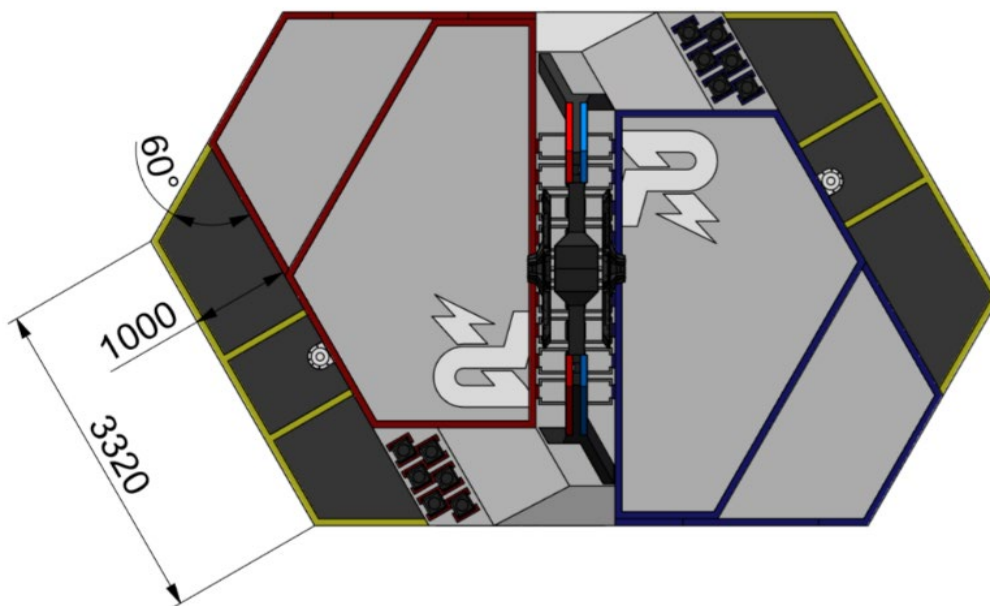

Figure 5-24 Resource Island Penalty Zone

If any robot violates the specification, it will get the following penalties. All penalties for violations occurring during the period will be executed after the violating robot leaves the Penalty Zone.

## Violations and Penalties:

- Standard and Hero are prohibited from blocking the landing area and the area to obtain Projectile Containers.
- If any robot stays in the Penalty Zone for T second(s) and disrupts Engineer of the opposing team in landing, leaving the Resource Island or obtaining Projectile Containers, the referee will issue a Level X Warning. The actual situation shall be determined by the Head Referee and the Chief Referee. The violating Standard or Hero must immediately leave the Penalty Zone. The violating Engineer is not necessary to leave the Penalty Zone, but it can no longer disturb the other side in landing, leaving the Resource Island or obtaining Projectile Containers.

T Second(s)	Level X Warning
T < 3	1
3 < T < 10	2
T > 10	3

- If Standard or Hero stays in the Penalty Zone and its space above for more than 10 seconds, constantly disturbs Engineer of the opposing team in landing, leaving the Resource Island or obtaining Projectile Containers, and gets in serious collisions with the opposing team's robot, the referee will issue a Level 4 Warning. The actual situation shall be determined by the Head Referee and the Chief Referee.
- If any side of Engineer repeatedly disturbs the other side in landing, leaving the Resource Island or obtaining Projectile Containers, and gets in serious collisions with it, the referee will issue a Level 4 Warning. The actual situation shall be determined by the Head Referee and the Chief Referee.

## 5.6.2 Projectile Depot



When Standard strikes the Power Rune, the 17 mm projectile may fall into the Projectile Container.

The Resource Island is provided with 21 fixed Projectile Container grooves, which holds full Projectile Containers. In each Projectile Depot on both sides of the Resource Island, there are six Projectile Containers with six 42 mm standard projectiles. In the Projectile Depot of the central area, there are nine Projectile Containers containing twenty 42 mm standard projectiles.

Before each round, Side Referees will place projectiles in Projectile Containers and then place the containers in the appropriate positions on the Resource Island as shown below:

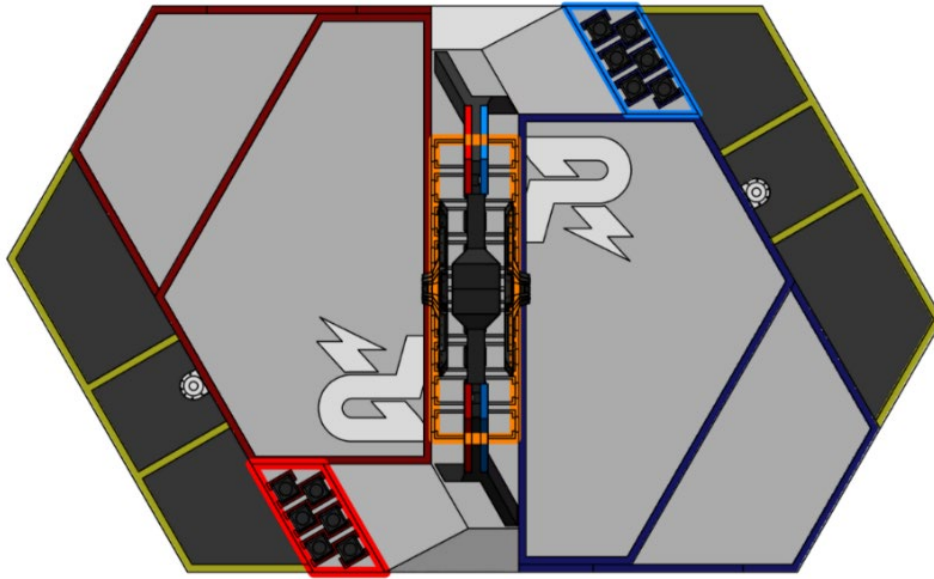

Figure 5-25 Location of Projectile Containers

The central area Projectile Containers will rise twice. The first time is at the start of the match, the second is after three minutes of the start. Engineer can move or take away containers to obtain projectiles. If Projectile Containers are not fully raised and in still state, Engineer cannot grab the Projectile Container or obtain projectiles from the Projectile Container. The blue frame in the central area below identifies Projectile Containers that are raised for the first time, and the red frame identifies those for the second time.

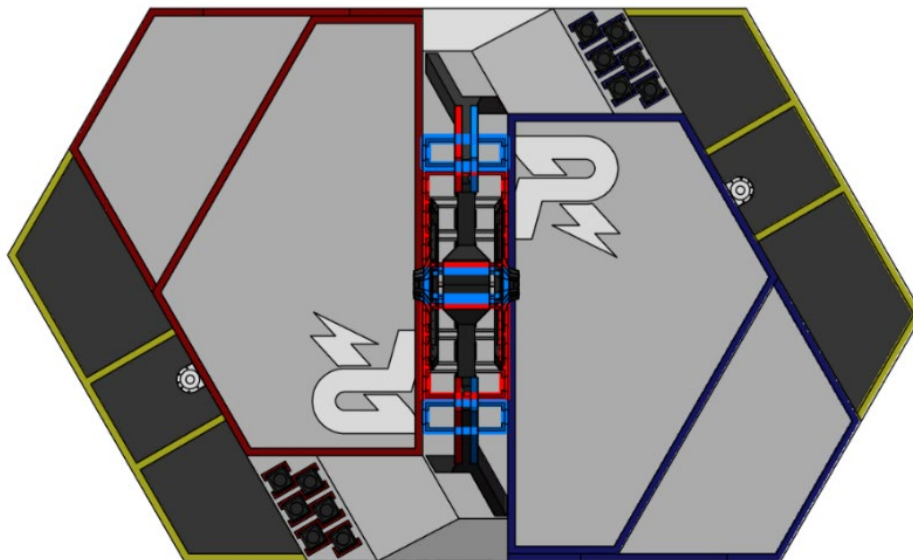

Figure 5-26 Raising Position of Projectile Containers

## Projectile Container

Projectile Container is a 200\*200\*200 mm cube. Its six faces are chamfered and it is made out of EVA. During a match, robots can use Projectile Containers as obstacles.

The top side of the Projectile Container has a hole with a diameter of 115 mm. The hole depth of different types of Projectile Container is different. The depth of the Projectile Containers in the middle of the Resource Island is 150 mm, and the depth of the Projectile Containers on both sides is 70 mm.

**Violations and Penalties:**

If any robot grabs Projectile Containers or obtains projectiles from the Containers before they has been raised, the referee will issue a Level 3 Warning.

**Projectile Containers on both sides of the Resource Island:**

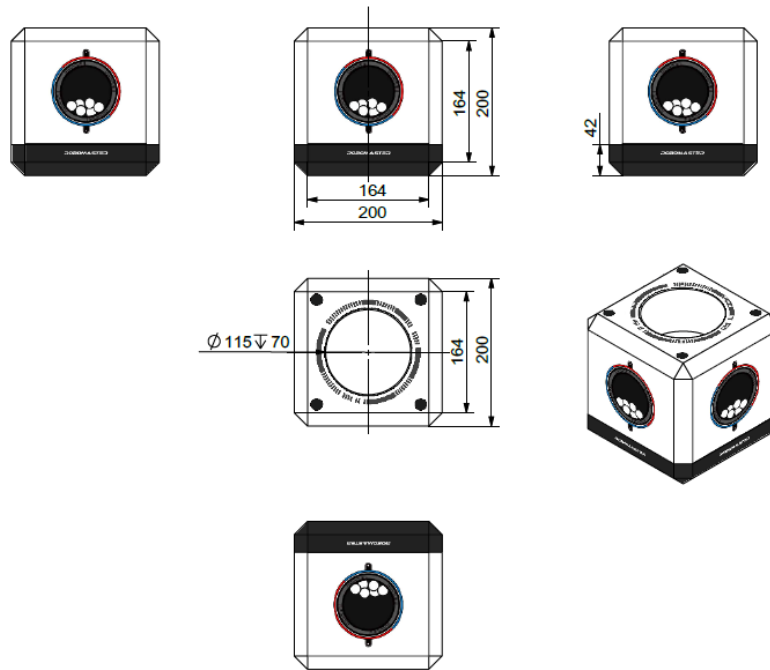

Figure 5-27 Projectile Containers on Both Sides of the Resource Island

**Projectile Containers in the central area of the Resource Island platform:**

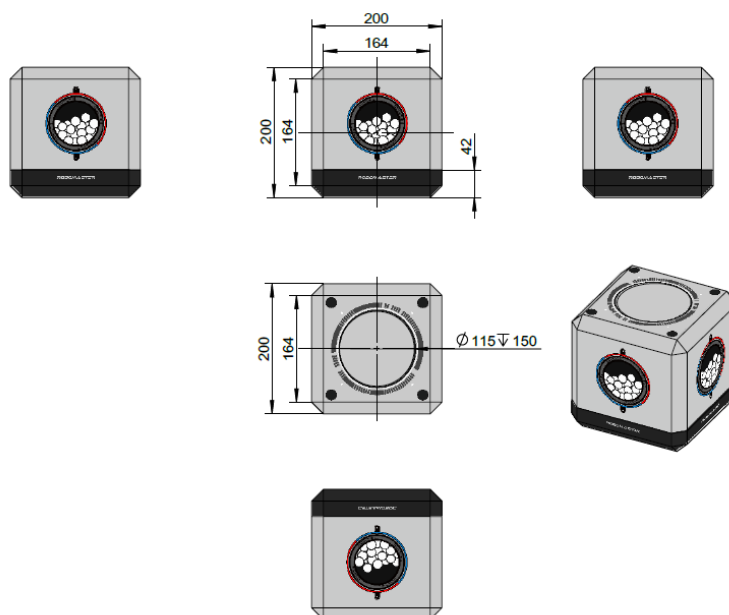

Figure 5-28 Projectile Containers in the Central Area of the Resource Island Platform

### 5.6.3 Assistive Column

On both sides of the Resource Island, there are two Assistive Columns which are made of Q235 carbon structural steel with a matt surface. Engineer can use the Assistive Column with its Landing Mechanism to ascend to the Island and obtain projectiles.

During the match, no robot shall set Projectile Containers on the Assistive Column.



- Since the surface of the Assistive Column is inevitably scratched from repeated use in the Battlefield, the mechanical structure of robots should be properly designed based on this assumption.
- Teams need to consider the possible impact to their own robots with a Projectile Container placing on the plane or stair of the Resource Island and prepare an appropriate solution.
- When Engineer uses the Assistive Column to ascend to the Resource Island, its mechanical structure will touch the Column. Teams should take this into consideration when designing robots and avoid structural damage to the mechanical structure.
- The connection between the step surface with a diameter of 180 mm and the two sides of the round tube with a diameter of 80 mm on the Assistive Column may have an inevitable structure (solder joint and surface finish) by improper processing.

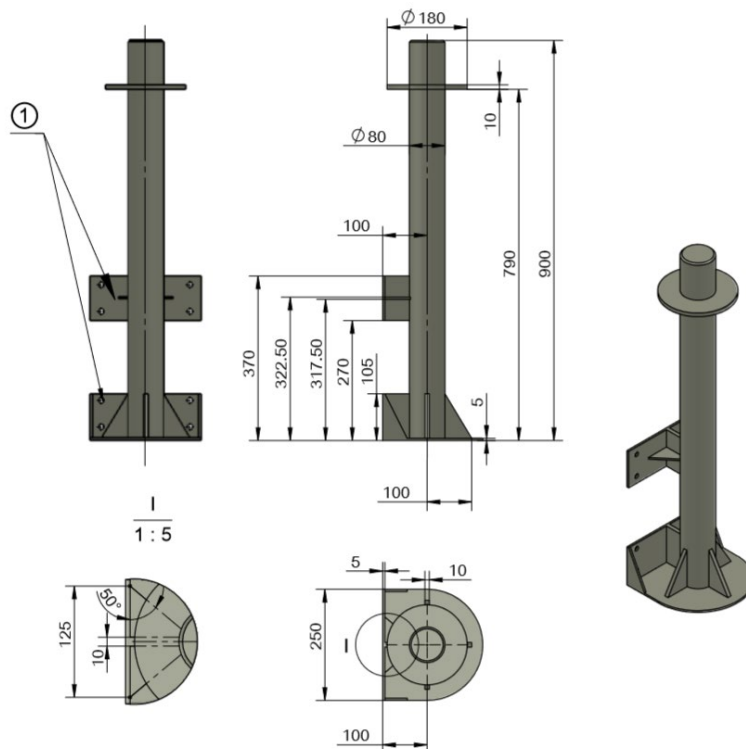

- ① Holes of the Assistive Column are connected to the Resource Island by bolts, which are M8 hex cup head self-tapping screw

Figure 5-29 Resource Island Assistive Column

#### Violations and Penalties:

During a match, if a robot sets Projectile Containers on the Assistive Column, the referee will issue a Level 4 Warning.

## 5.6.4 Assistive Column Penalty Zone

The area around the Assistive Column demarcated by a blue square 1000 mm in length is the Assistive Column Penalty Zone, as shown in the blue frame in the following figure.

During the match, no robot shall place or discard Projectile Containers in the Assistive Column Penalty Zone.

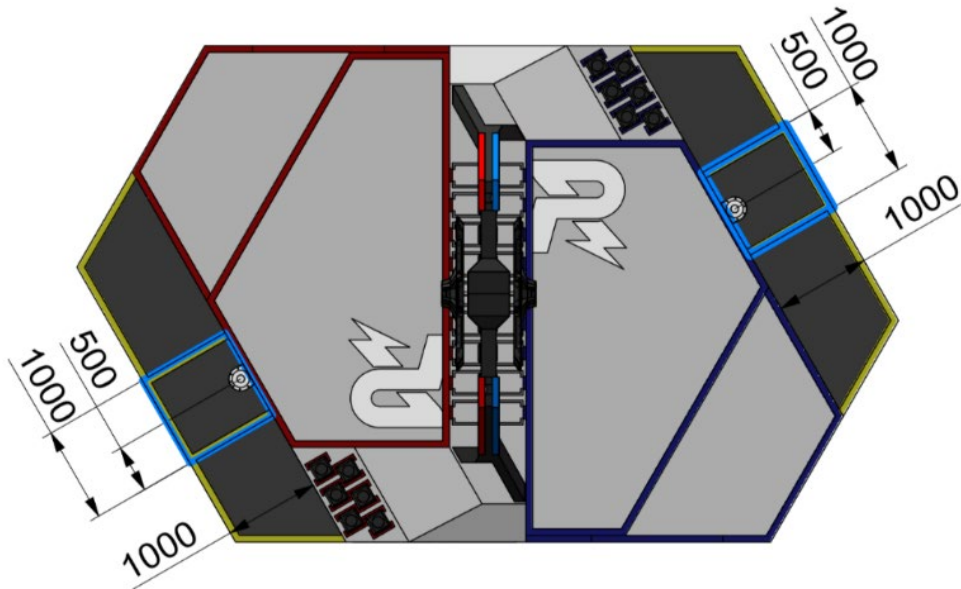

Figure 5-30 Assistive Column Penalty Zone

### Violations and Penalties:

If any robot places Projectile Containers in the Assistive Column Penalty Zone with a mechanical arm or other methods (such as shooting), the referee will issue a Level 2 Warning. The actual situation shall be determined by the Head Referee.

## 5.6.5 Power Rune



- The next version of Rules Manual will fine-tune the parameters such as the rotation speed, structure and dimensions of the Power Rune, but such adjustments will not affect the identification of it.
- Due to the heavy weight in the middle of the bridge, there will be a slight fall and the fall range is 0-50 mm.
- Due to observation viewing angle problems and the transmission gap, some Power Rune may be seen when observing one side's Power Rune.

The Power Rune is located in the center of the Resource Island, with one is the blue team and the other the red team. When the red and blue team's Power Runes rotate together, that is, when the red Power Rune rotates clockwise, the blue Power Rune also rotates counterclockwise (the rotation direction is determined by the direction of rotation when facing the Power Rune of one's own side). During the competition, the Power Rune rotates at a constant speed of 10 RPM (Round-Per-Minute).

The direction of rotation of the Power Rune changes in every round of a match. The direction of rotation

of the first round of each match is: The red team, clockwise and the blue team, counterclockwise. The alternate number of directions of rotation varies according to the competition system. For example, in a BO3 competition, if you play 3 games, the red team power rune rotates clockwise in the first game; in the second game, the red team Power Rune rotates counterclockwise; in the third game, the red team Power Rune rotates clockwise.

When activating one side's power rune, the corresponding team gains twice the attack power bonus for one minute. The red team can only activate the red team Power Rune and the blue team can only activate the blue team Power Rune. Both sides can strike the Power Rune at the same time. If one side's Power Rune preferentially enters the activated state (see [Figure 5-35](#)), the other side's Power Rune cannot continue to be activated.

Take the red team's Power Rune as an example and this also applies to the blue team.

The Power Rune is distributed evenly with five Large Armor Modules. The specific location and dimensions of Large Armor Module are as follows:

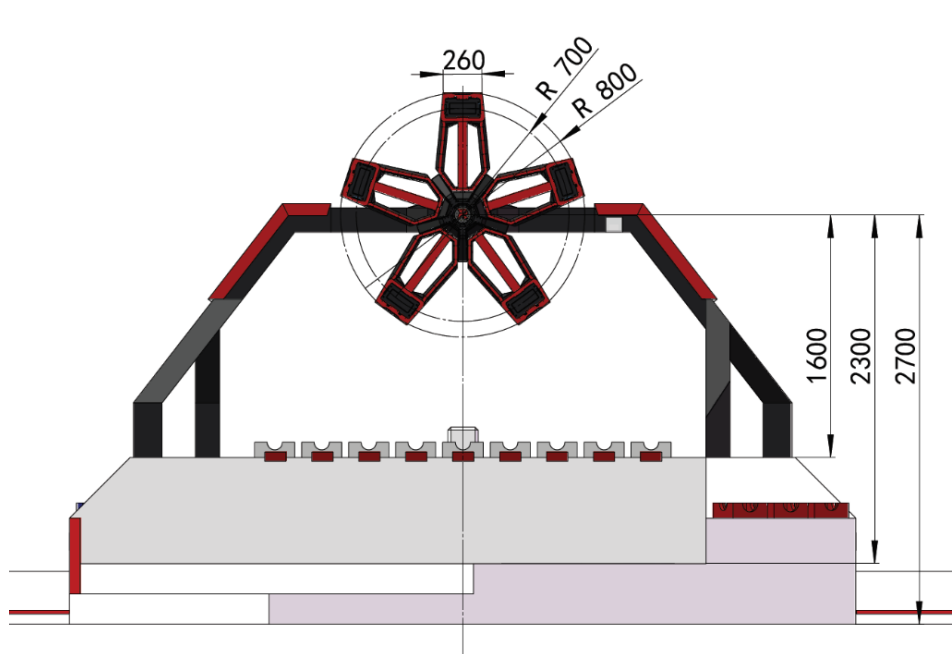

Figure 5-31 Location of Large Armor Module

## Status

The Power Rune has five statuses: Unavailable, Available, Activating, Activated and Activation Failed.

### 1. Unavailable

Four minutes before the competition, the Power Rune is unavailable and stands still as shown below:





Figure 5-32 Power Rune is Unavailable

## 2. Available

After four minutes of the start, the Power Rune begins to rotate. When the red team robot reaches the red team's Bridge Top Platform and stays for 3 seconds (which means the robot enters into the green frame of the Bridge Top Platform (see [Figure 5-14](#)). The robot's RFID Interaction Module detects the RFID Interaction Module card within the Bridge Top Platform and prompts on the client), the red team's Power Rune will illuminate one of the five Armor Modules randomly, and the center axis of the bracket will have an arrow-shaped light flow effect as shown below. At this moment, the Power Rune is available.



Figure 5-33 Power Rune is Available

## 3. Activating

When the Power Rune is available, if a projectile hits the illuminated armor module within 2.5 seconds, the bracket will be fully illuminated. At the same time, the Power Rune will randomly illuminate one of the remaining four Armor Modules, and so on. At this moment, the Power Rune is activating.

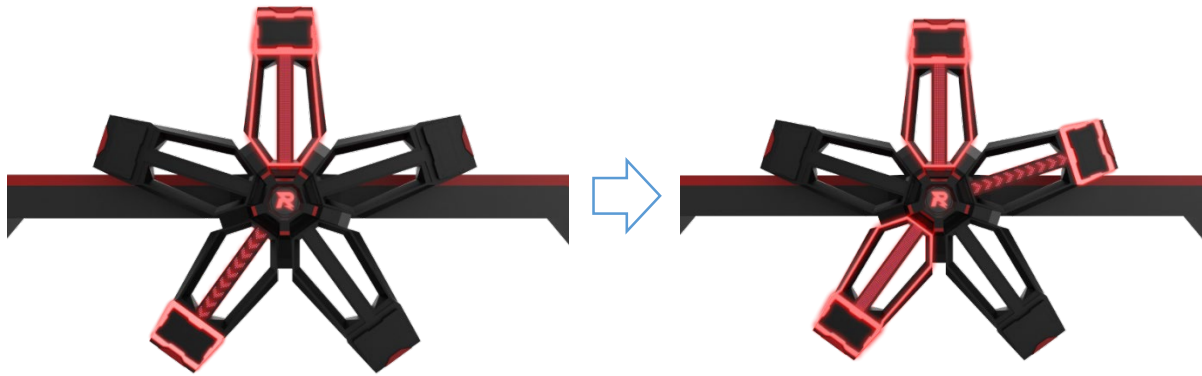

Figure 5-34 Power Rune is Activating

#### 4. Activated

If all five Armor Modules are illuminated, the Power Rune is activated.



Figure 5-35 Power Rune is Activated

#### 5. Activation Failed

In the activation process, if the randomly illuminated Armor Module is not hit within 2.5 seconds, the activation fails, and the Power Rune will return to the unavailable status.

## 5.7 Flight Zone

Flight Zone is an area where Aerial is permitted to operate, including a Landing Pad and Aerial Safety Rope.

### 5.7.1 Landing Pad

The Landing Pad is where Aerial takes off and lands. Before the start of each round, Aerial must be placed on the Landing Pad.

There are indicators around the Landing Pad, as shown in the figure below. The indicator lights can display the energy (E) of Aerial in real time: If  $E = 0$ , the indicator light is off. If  $E < 100$ , the indicator light

flashes. The more energy the aerial robot accumulates, the longer the indicator light is lit. If  $E = 100$ , the indicator light is completely lit and flashes regularly. At this time, the Aerial Gimbal Operator can choose whether to supply power to the Launching Mechanism.

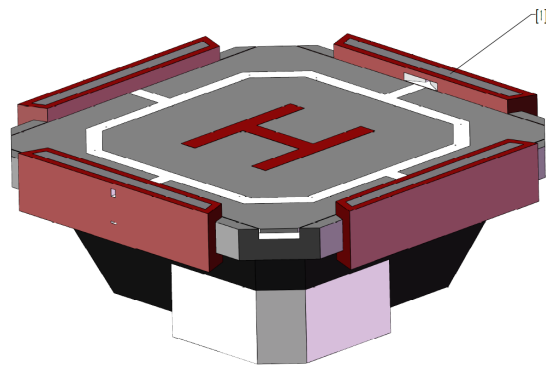
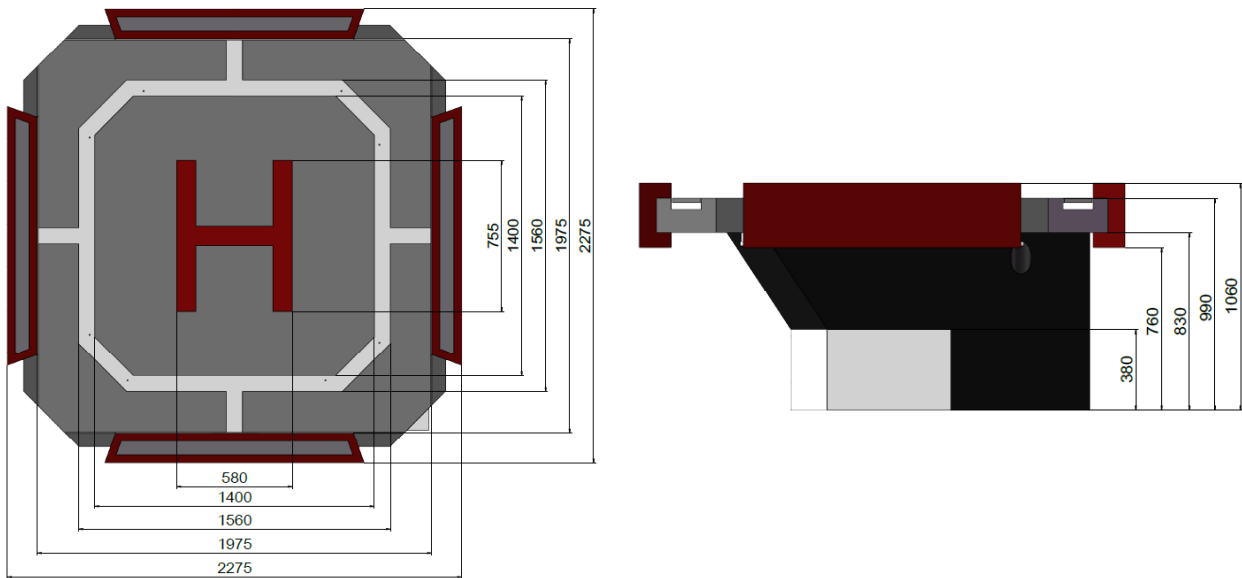

[1] Energy Indicator

Figure 5-36 Landing Pad

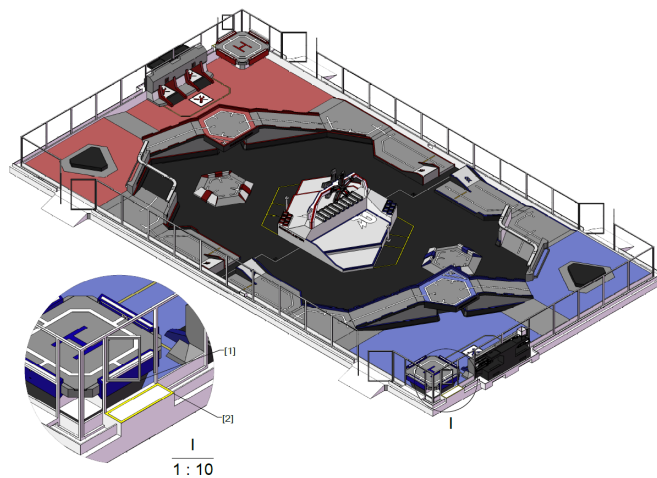

[1] Projectile Supply Area [2] Projectile Supply Window (1300\*880mm)

Figure 5-37 Projectile Supply Area of Projectile Supplier

## 5.7.2 Aerial Safety Rope

Aerial Safety Rope is attached to a pulley, which slides on a fixed horizontal steel cable over the Battlefield. This steel cable is four meters above the ground, and the Aerial Safety Rope is three meters long.

Before each round, both teams must connect their Aerial to the Safety Rope using the bead ring in order to limit the flight range and protect the Battlefield. The flight distance of Aerial in the Battlefield is limited. There is a snap ring in the center of the cable that sets up Aerial (16 meters from the Battlefield fence to the Landing Pad of its own team). When the bead ring of the Safety Rope reaches to the snap ring of the cable, Aerial can no longer move forward.

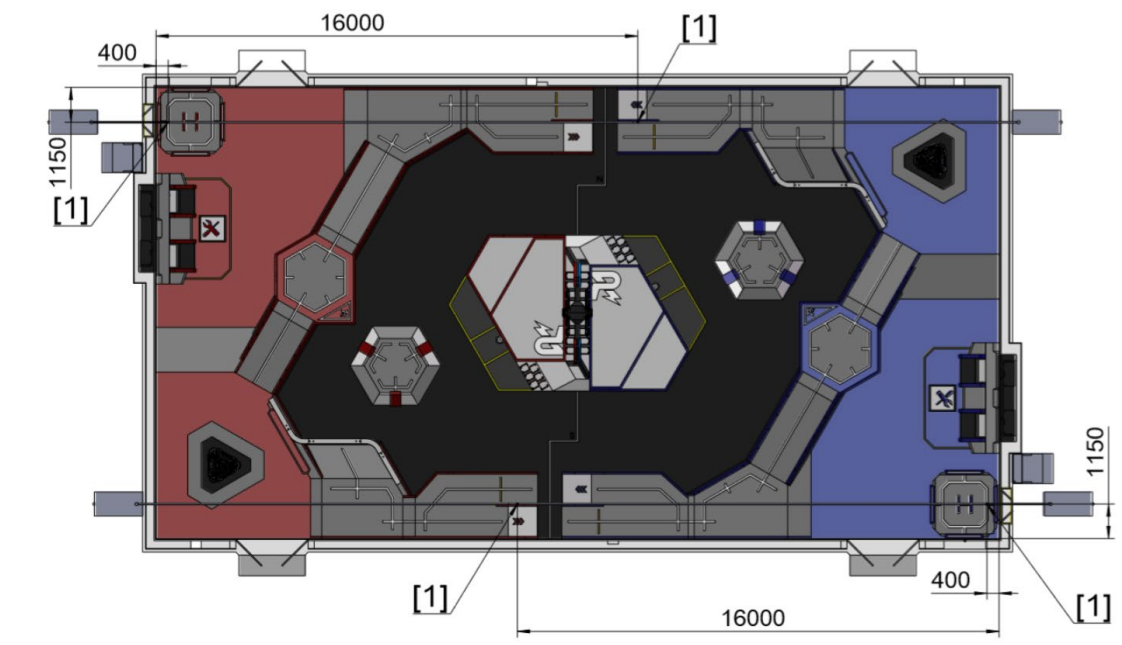

[1] Snap Ring

Figure 5-38 Position Relation between Aerial Safety Rope and Battlefield

During the competition, the distance between the lowest point of Aerial in flight and the floor shall not be less than 1300 mm (which is the same as the lower surface of Sentry Rail and the Open Zone). Aerial should actively avoid ground robots.

## 5.8 Operator Room

On both sides of the Battlefield, there are Operator Room of the red team and blue team and Pilot Room, which are equipped with computers of the corresponding robot and communication devices for referees. The Operator Room is the only place where operators can control their robots in real time during the competition.

## 5.8.1 Facility

- ⊘ ● The operator is not allowed to bring his own computer.
- The participating team members are prohibited from using the official equipment power supply to supply power to their own equipment.

During the Regional Competition, the Operator Room includes five computers and each has mouse, keyboard, USB hub and headset. As some equipment such as mouse and keyboard may suffer from performance degradation over time, it is recommended by the RMOC that operators bring their own equipment and set up during the 3-minute setup period.

There is no extra power supplied to the Operator Room. Operators must therefore bring their own power supply for their own equipment.

## 5.8.2 Operator

Operator can only operate on his corresponding computer and cannot change after a round has begun. Operator can be substituted after each round.

Standard, Hero, and Engineer can only have one Operator each. Since Sentry is a fully automated robot, it has no operator.

Below shows the category of Aerial Operator and his duty.

Table 5-1 Aerial Operator Description

Operator Category	Qty.	Duties	Position During the Match	Available Visual Information
<b>Aerial Gimbal Operator</b>	1	Control the Aerial Gimbal	Operator Room of red/blue team	Vision by Aerial
<b>Pilot</b>	1	Control Aerial	Pilot Room of red/blue team	Directly see the Aerial in the Competition Area and control its flying
<b>Projectile Supplier</b>	1	<ul style="list-style-type: none"> <li>● Manually load and supply projectiles to Aerial</li> <li>● 30 seconds of projectile supplying countdown starts when the Projectile Supply Window is open</li> </ul>	Designated area next to the Pilot Room (see <a href="#">Figure 5-37</a> )	-



- Aerial Gimbal Operator can send one-way voice commands to Pilot via the equipment provided by the RMOC, but Pilot cannot respond back.
  - Communication with the Projectile Supplier is only allowed when the Pilot thinks that Aerial needs projectile supply. At some other time, any verbal or physical communication between the Projectile Supplier and the Pilot is prohibited.
  - If a team does not have Aerial, the team's Aerial Gimbal Operator, Pilot and Projectile Supplier are not allowed to enter the Operator Room and need to watch the game from the Pit Area.
  - Pilot can connect to the remote controller for the status of Aerial via his phone, but he cannot use the VTM transmission of the remote controller.
- 

### 5.8.3 Operator Room Referee

In the Operator Room, there are referees who are responsible for maintaining order, helping technicians to solve problems and ensuring the normal operation of official equipment during the setup period. Operators in the Operator Room must wear the headsets provided by the RMOC in order to receive instructions from the Head Referee. Operators cannot leave their post without referee's permission.

#### Violations and Penalties:

- The use of an unauthorized power supply in the Operator Room is regarded as damaging components.
- If a Projectile Supplier spends more than 30 seconds supplying projectiles, the Referee will issue a verbal warning and ask the Supplier to return to the designated area (see [Figure 5-37](#)). If three verbal warnings are not heeded, the Projectile Supplier will be ejected to the Pit Area. In the remaining rounds of the match, the team is not allowed to have a substitute Projectile Supplier to supply Aerial, nor may the Pilot of the team supply Aerial during the seven-minute round.
- Operator, Aerial Gimbal Operator or Pilot who leaves his post, or Projectile Supplier who leaves his designated area will receive a verbal warning. If three verbal warnings are not heeded, the team with the member who does not comply with the warnings will be punished as lose for the round.
- Operator, Aerial Gimbal Operator or Pilot who does not wear headsets will receive a verbal warning. If three verbal warnings are not heeded, the member who does not comply with the warnings will be ejected from the Competition Area, and the robot he operates will be ejected with a Level 4 Warning after the start of the match. The team is not allowed to have a substitute Operator enter the Operator Room in that round.
- Operator that changes his position after the start of a match will receive a verbal warning from the Operator Room Referee, and the Operator must return to his specified position. If three verbal warnings are not heeded, the member who does not comply with the warnings will be sent off with a Level 4 Warning, and the robot he operates will be ejected with a Level 4 Warning after the start of

the match. The team is not allowed to have a substitute Operator enter the Operator Room. If the ejected team member does not comply, the entire team will be punished as lose for the round.

## 5.9 Projectile

Projectile is the only acceptable component to attack robots. Robots must use projectiles to hit the Armor Modules of the enemy robots, causing damage to their HP and defeat them. Both 17 mm and 42 mm projectiles are used during a match.

Table 5-2 Projectile Parameters

Type	Appearance	Color	Size	Weight	Shore Hardness	Material
<b>42 mm Standard Projectile</b>	Similar to the shape and size of a golf ball	White	42.5mm±0.5mm	41 g ± 1 g	90 A	Plastic (TPE)
<b>17 mm Standard Projectile</b>	Round		16.9mm±0.1mm	3.0 g ± 0.1 g	90 A	Plastic (TPU)
<b>42 mm Luminous Projectile</b>	Similar to the shape and size of a golf ball	Transparent	42.5mm±0.5mm	41 g ± 1 g	90 A	Plastic (TPE)
<b>17 mm Luminous Projectile</b>	Round		16.9mm±0.1mm	3.3 g ± 0.1 g	90 A	Plastic (TPE)



Luminous Projectiles are used in the Final Tournament after the Knock-out Stage (Final 16).

### Violations and Penalties:

Robots must use official RM2019 projectiles and cannot use any unofficial projectiles. Any team being found to use unofficial projectiles will be regarded as cheating and disqualify once confirmed through investigation.

## 6. Competition Procedure and Rules

This chapter mainly covers the core competition procedures and penalty explanations for the Chinese Regional Competition, International Regional Competition, Wild Card Competition, and Final Tournament of the RoboMaster 2019 Robotics Competition (RM2019). During the official matches of RM2019, each team will prepare for the matches in the Preparation Area, arrive at the Inspection Area for the pre-match inspection, wait in the Staging Area, and finally enter the Competition Area to compete. Each team is required to leave the Competition Area and return to the Preparation Area after each match.



Specific locations of these areas and way of arrival will be introduced in the Participant's Manual published later in the Season.

---

### 6.1 General Competition Rundown

The official matches of RM2019 consists of the Group Stage and the Knock-out Stage. Depending on the Competition System, there are two, three, or five rounds in a match, which are called BO2, BO3 and BO5 Competition System respectively according to the general competition system of competitive games.

Each round consists of a Three-Minute Setup Period and a Seven-Minute Round Period. Between the two periods, there is a Twenty-Second Referee System Initialization Period.



After the end of the second and fourth round of a BO5 match, both teams have 10 minutes to work on their robots. When 10 minutes run out, the setup period of the next round begins.

---

Before each match begins, all robots need to pass the pre-match inspection performed by the RMOC, which is to ensure that all robots fulfill the technical specifications set by the RMOC for fairness. All teams must be guided by referees and volunteers to enter the Competition Area. By the end of each match, teams must clean up projectiles left in the Launching Mechanism of each robot and return them to the designated areas.

During the Three-Minute Setup Period, team members can enter the Battlefield to test and set up their robots as required. During the remaining 1 minute and 30 seconds, Operator needs to go to the Operator Room (including the Pilot Room) to check the status of the official equipment and prepare for the match. During the final 30 seconds, the remaining Pit Crew must return to the Pit Area. After the setup period, the match enters a Twenty-Second Referee System Initialization Period.

During the final five seconds of the Initialization Period, participants will hear a countdown alert sound, and see a countdown timer and a live animation. At the same time, the keyboard connected to the computer in the Operator Room will be locked. The round of match starts immediately after the countdown finishes.

When the time runs out or one team fulfills the criteria to win the round, a round comes to an end. Subsequently, the match immediately enters the setup period for the next round. When the winner is



determined, the match is over.

During the Seven-Minute Round Period, robots from both teams will compete on the Battlefield of the stadium. All robots must install the Referee System provided by the RMOC to record HP value and projectile hits and monitor the Launching Mechanism and Chassis Power Consumption. Besides, it cuts off a robot's power supply when its HP drops to zero. During the match, the real-time status of all robots is sent to both the Operator's computer and the Referee System's server. The Referee System server determines the outcomes of all rounds automatically while referees will penalize foul plays of robots, Operator, Aerial Gimbal Operator or Pilot.

The procedure of a single match is shown below:

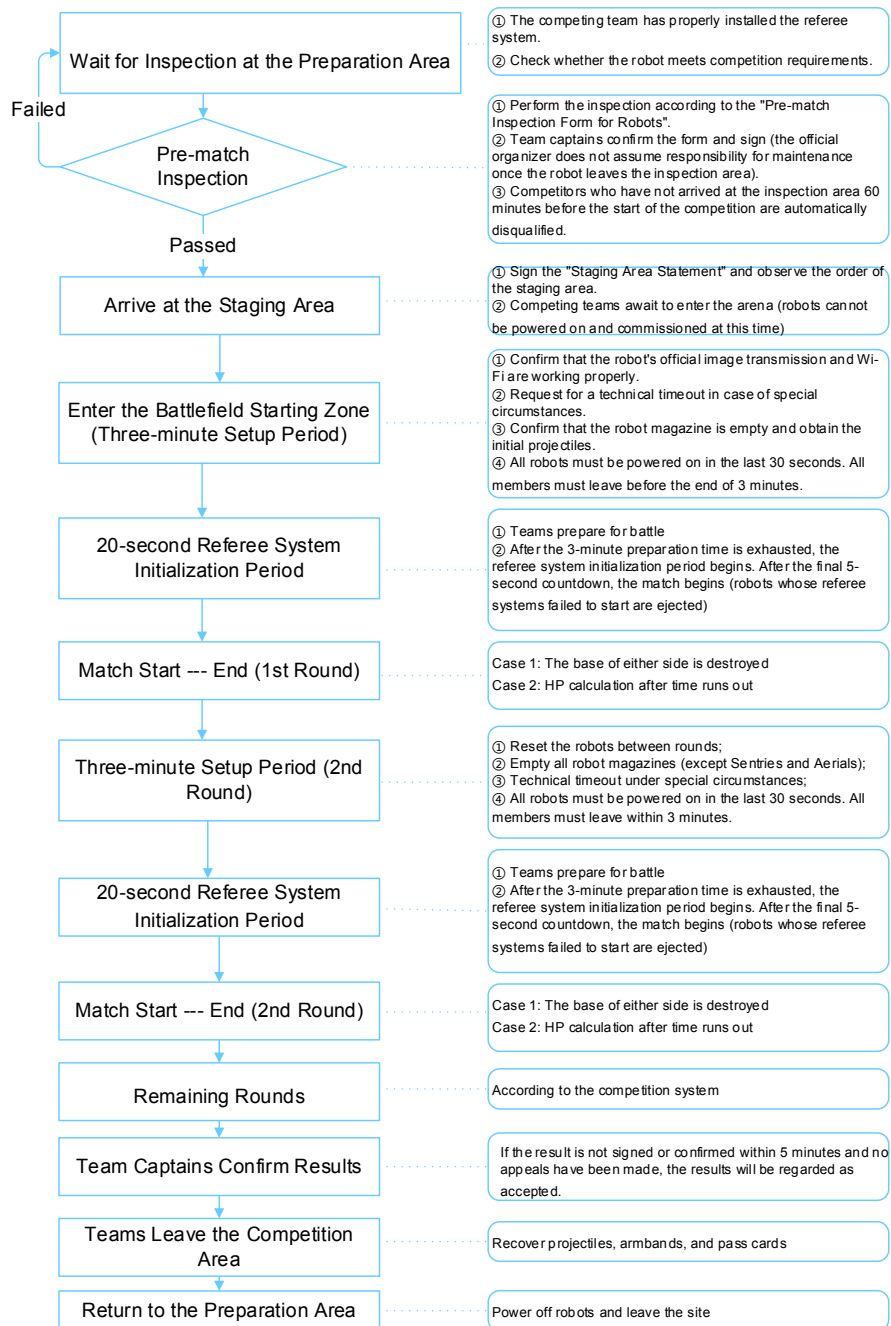

Figure 6-1 Procedure of A Single Match

## 6.2 Criteria Required to Win

The ranking of the group round robin is determined by the total score of each game; the knock-out stage is determined by the number of wins.

Table 6-1 Result and Score of Group Round Robin

Competition System	Competition Result	Score
<b>BO2</b>	2:0	Winning team obtains 3 points
	1:1	Each team obtains 1 point
	0:2	Losing team obtains 0 point
	1:0	(one round draw): The team winning one game gains one point, and the team losing one game gains 0 point
	0:0	(two rounds draw): Each team obtains 0 point

Table 6-2 Criteria Required to Win of Knock-Out Stage

Competition System	Criteria Required to Win
<b>BO3</b>	The team that wins two rounds is crowned the winner
<b>BO5</b>	The team that wins three rounds is crowned the winner

### 6.2.1 A Single Round

Criteria for Winning a Single Round as shown below:

1. When the Base of one team is destroyed, the round ends immediately and the surviving team wins.
2. When the entire seven-minute round period runs up, if the Bases of both teams have not been destroyed, the team with the higher Base HP is the winner.
3. When the entire seven-minute round period runs up, if the Bases of both teams have not been destroyed and both have the same remaining Base HP, the team with the higher HP Deduction wins.
4. When the seven-minute round period runs up, if the Bases of both teams have not been destroyed, both have the same remaining Base HP and HP Deduction, the team with the higher total remaining HP of all robots wins.
5. If these criteria still cannot determine the winner, the round is considered a draw. A draw in the Knock-out Stage leads to an extra round until a team wins.

### 6.2.2 Rankings for Group Stage

The following criteria are used to determine rankings in descending order of priority:

1. The team with the higher match points ranks higher.
2. If the total match points are the same, the team with the higher total Net Base HP ranks higher.
3. If the total Net Base HP are the same, the team with the higher total HP Deduction ranks higher.
4. If two or more teams still tie for the same place according to these criteria, the RMOC will arrange a playoff match on a round-robin basis.



- HP Deduction: At the end of each round, the total damage accrued from successfully hitting the armor modules of the opposing team's robot and leading to its deduction of HP.
    - HP deducted from the Initial Firing Speed exceeds the limit, Barrel Heat exceeds the limit, Chassis Power Consumption exceeds the limit and the Referee System goes offline are not counted as HP Deduction.
    - HP deducted from violations and penalties (Level 1 to 5 Warnings) determined by the referee will be counted as the enemy's HP Deduction, influencing the enemy's Base remaining HP.
  - Net Base HP: At the end of each round, the remaining Base HP of one team minus that of the opposing team.
  - Total Remaining HP: At the end of each round, the total value of the remaining HP of all surviving robots of a team.
- 

## 6.3 Competition Area Personnel

### 6.3.1 Specification for Participant

Participants should follow specifications as shown below:

- During each match, 14 Pit Crew per team at most can enter to prepare for the match (including the team's Captain, Operator, Supervisor, and Advisor). The Captain and at least one Supervisor present at the scene must enter the Competition Area as Pit Crew.



Participants who enter the Staging Area and Competition Area are called Pit Crew.

---

- During the seven-minute round period, Operators must stay in their respective Operator Rooms. Other Pit Crew must stay in the Pit Area outside of the Battlefield. Pit Crew are prohibited from leaving the Area without the Referee's permission.
- Pit Crew must wear goggles provided by the RMOC when entering the Battlefield.
- Projectile Supplier must wear a long-sleeved top and the helmet and goggle provided by the RMOC.

#### Violations and Penalties:

- If any team has more than 14 Pit Crew, the Referee will issue a verbal warning. The extra member must leave the Staging Area and Competition Area. If three verbal warnings are not heeded, the

violator will be punished as lose for the round. The actual situation is determined by the Chief Referee.

- Pit Crew who leave the Pit Area without the Referee’s permission will be given a verbal warning. If three verbal warnings are not heeded, the violator will be ejected and for all of the remaining rounds of the match, the team is not allowed to have a substitute member to enter the Competition Area. If the team member continues to stay in the Competition Area, the team will be punished as loses for the round. The actual situation is determined by the Chief Referee.
- Pit Crew who enter Battlefield do not wear goggles as required will be sent off from the Competition Area. The actual situation is determined by the Chief Referee.
- Projectile Supplier who does not wear a long-sleeved top, helmet or goggle may not supply projectiles for Aerial.

### 6.3.2 Duty of Event Staff

Teams will be guided by volunteers and staff members throughout the competition. Apart from volunteers and general staff members, teams will also come into contact with the following event staff from the RMOC:

Table 6-3 Duty of Event Staff

Role	Duty
<b>Head Inspector</b>	Oversees all pre-match inspections and has the final decision on whether a team passes the pre-match inspection.
<b>Inspector</b>	Assists with pre-match inspections but does not get involved in or assist any team with the maintenance of robots in any way.
<b>Chief Referee</b>	Has the final decision and right of interpretation regarding competition rules. During the competition, Chief Referee issues severe violations and penalties (disqualification), accepts appeals after the match, and has the right to impose additional penalties before and after the competition.
<b>Head Referee</b>	In charge of the execution of Referees' decisions, controls the competition process, executes Official Technical Timeouts, receives and confirms Team Technical Timeout and ensures the validity of match results.  During the match, Head Referee receives information from Side Referees and Operator Room Referees, and confirms and executes Level 1-5 Warnings for violations.

Role	Duty
<b>Side Referee</b>	Executes competition procedures, guides team members to enter and exit the Battlefield, reports a robot's violation to the Head Referee during matches. Side Referee also receives applications of Team Technical Timeout and reports to the Head Referee for confirmation.
<b>Operator Room Referee</b>	Executes competition procedures, guides participants to enter and exit the Operator Room, reports Operator's violations and Technical Timeout to the Head Referee, assists operators in solving technical problems of the Operator Room's equipment, can apply for Official Technical Timeout, but does not assist participants in repairing their equipment.
<b>Technician</b>	Maintains components of the Battlefield, assists participants in solving technical problems with the Referee System during the setup period, can apply for Official Technical Timeout, but does not assist participants in repairing and maintaining their robots.

During the competition, the Chief Referee has the final right of interpretation regarding competition rules. Any questions related to competition rules can only be consulted with the Chief Referee.

## 6.4 Pre-match Procedure

### 6.4.1 Inspection Specification

To ensure that robots meet the required specifications, each team must undergo the pre-match inspection in the Inspection Area. For requirements of pre-match inspection, please refer to [Appendix 5 Pre-match Inspection Form](#).

Teams must follow inspection specifications and if violating, they will get the following penalties:

Table 6-4 Inspection Specification and Violations and Penalties

Inspection Specification	Violations and Penalties
Each team must reach the Inspection Area to start the pre-match inspection at least 60 minutes before the match begins.	Except for emergencies, teams that fail to reach the Inspection Area within the specified time will lose the match. The actual situation is determined by the Head Inspector and Chief Referee.

Inspection Specification	Violations and Penalties
<p>A maximum of 14 team members can enter the Inspection Area. Standard must be brought into the Inspection Area by one team member while Sentry, Aerial, Hero, and Engineer be brought by two members. One team member must also oversee the pre-match inspection work. Team members are prohibited from entering the Inspection Area without permission before their robots enter the Inspection Area.</p>	<p>Extra team members or those who do not participate in the pre-match inspection must leave the Inspection Area.</p>
<p>During the pre-match inspection, inspectors will place a Pass Card on robots that pass the inspection. Only robots with a Pass Card can enter the Staging Area and Competition Area. Teams need to modify their robots that fail the inspection in a designated area or the Preparation Area until the inspection requirements are met.</p>	<p>Robots without a Pass Card cannot enter the Staging Area and Competition Area.</p>
<p>Required robots must pass the inspection to be qualified for the round. When the inspection is complete, the team Captain must sign the Inspection Form to confirm that they agree with the inspection results. (see <a href="#">Table 3-2</a>)</p>	<ul style="list-style-type: none"> <li>● If any required robot fails the pre-match inspection, the team is deemed as give up its qualification for the round of the match and lose the match.</li> <li>● After the team Captain signs for confirmation, no objection may be raised to the results of the inspection. Teams will be deemed as cheating if any robot that fails the pre-match inspection is found inside the Competition Area. Any round attended by the above-mentioned robot will be directly recorded as failed. The actual situation is determined by the Head Referee and Chief Referee.</li> </ul>

## 6.4.2 Staging Area Specification

When the pre-match inspection is complete, the teams must arrive at the Staging Area at least 15 minutes before their match begins. All robots and team members must be re-checked at the Staging Area.

Teams must follow Staging Area specifications and if violating, they will get the following penalties:

Table 6-5 Staging Area Specification and Violations and Penalties

Staging Area Specification	Violations and Penalties
<p>Team Captain must sign a Staging Area Statement 10 minutes before every match begins to confirm that the team is able to compete.</p>	<p>Except for emergencies, if the team Captain fails to sign the Staging Area Statement ten minutes before the match, then the team will be disqualified and automatically lose the match. The actual situation is determined by staff of the Staging Area and the Chief Referee.</p>
<p>All robots in the Staging Area must pass the pre-match inspection and have a Pass Card placed on them.</p>	<p>Robots without a Pass Card will be denied entry to the Competition Area.</p>
<p>The total number of Pit Crew per team in the Staging Area cannot exceed 14.</p>	<p>Extra Pit Crew will be asked to leave the Staging Area.</p>
<p>Robots cannot be powered on to be adjusted or maintained in the Staging Area. If robots require maintenance after entering the Staging Area, the team must first inform staff of the Staging Area. Only when the Pass Card on the robot be removed and the signed Staging Area Statement become invalid can the robot that needs maintenance return to the Maintenance Area. When the maintenance is finished, the team must bring their robots back to the Inspection Area for re-inspection. After passing the re-inspection, the team returns to the Staging Area and the Captain resigns the Statement. If a delay results in the failure to sign the Statement on time, the robot cannot play, and the team is held responsible.</p>	<ul style="list-style-type: none"> <li>● The first time a team powers on his robots will receive a verbal warning from Staging Area staff. If three warnings are not heeded, the team will lose the round. The actual situation is determined by the Staging Area staff and the Chief Referee.</li> <li>● After the robots or the participating team members leave the staging area without authorization, the robot or the participating team member will be prohibited from entering the competition area during this game.</li> </ul>

## 6.5 Match Procedure

Since the RM2019 Competition has a tight schedule, many teams and is streamed online in real time, any delay or accident will have a negative impact on our teams and a million audience. To ensure the

normal proceeding, all participants must adhere to the pre-arranged schedules, instructions, and guidelines provided by the RMOC event staff, referees and volunteers, and abide by the rules and regulations as outlined in the Rules Manual.

Teams can only enter and set up their robots in the designated area of the Competition Area after leaving the Staging Area. When the previous match ends, the Referee will allow the next team to take its robots to the entrance of the Battlefield and wait for further instructions. After the Battlefield is ready, the setup period countdown begins, and the Referee will guide the participating team into the Competition Area.

### 6.5.1 Penalty Type

All robots are continuously monitored by the Referee System. The Head Referee and Side Referees will announce rule violations and penalties, as well as address any emergencies that occur. Severe violations and appeals in the competition will be publicized.

Each robot starts with 9 points at the beginning of each match. If a robot gets a Level 2 Warning, it will lose 2 points and for Level 3 Warnings, 4 points. When the points is less than or equal to 5, the robot's avatar on the interface of the robot server client will display a yellow exclamation mark. When the points is less than or equal to 2, the avatar will display a red exclamation mark instead. When the points is less than or equal to 0, the violating robot will be ejected.

Table 6-6 Warnings and Penalties That A Referee Executes

Type	Penalty
<b>Warning (Level 1 Warning)</b>	The operation interface of all Operators from the violating team will be blocked for three seconds upon receiving a warning.
<b>HP Deduction (Level 2 Warning)</b>	<ul style="list-style-type: none"> <li>● The operation interface of all Operators from the violating team will be blocked for five seconds.</li> <li>● The Referee System will automatically deduct 5% of the current maximum HP from all surviving robots (except Aerial and Base) of the violating team.</li> <li>● The violating robot will lose 2 points.</li> </ul>
<b>HP Deduction (Level 3 Warning)</b>	<ul style="list-style-type: none"> <li>● The operation interface of the violating Operator will be blocked for ten seconds and other operators on the violating team for five seconds.</li> <li>● The violating robot will be deducted 50% of its current maximum HP and other surviving robots (except Aerial and Base) 5% of their current maximum HP.</li> <li>● The violating robot will lose 4 points.</li> </ul>



Type	Penalty
<b>Ejection (Level 4 Warning)</b>	<ul style="list-style-type: none"> <li>● Ejected violating robots: In the round of the match, ground robots and Sentry are immediately slain by the Referee System (deduct all HP). Aerial will have its Launching Mechanism (including the loading mechanism and friction wheel) powered off and its VTM disconnected and must immediately land on the Landing Pad. Robots that are ejected cannot be revived.</li> <li>● Ejected Operators or other members: Members ejected by the Referee must immediately leave the Competition Area and no substitute Operator or Pit Crew Member is allowed for the remaining rounds of the match. The robot operated by the ejected Operator will be ejected at the start of all rounds of the current match. The amount of HP deducted from the ejection will be counted towards the other team's HP Deduction.</li> </ul>
<b>Loss (Level 5 Warning)</b>	<ul style="list-style-type: none"> <li>● If a Loss is issued before the match (not including the Three-Minute Setup Period) and the match has not yet started, the Pit Crew of the offending party must all leave the Competition Area. The Base HP and all robots' HP of the losing team are set to zero, while the opposing team's Base HP and robots' HP remain their maximum.</li> <li>● If a Loss is issued during a match (including the three-minute setup period), the Head Referee directly slays all robots of the offending team via the Referee System, and the round is over. The Base HP and all robots' HP of the losing team is set to zero, while the opposing team's Base HP and robots' HP remain at the amount when the round ends. At this point, Pit Crew of both sides must listen to the Referee's instruction to power off and move robots off the Battlefield.</li> <li>● If a Lose is issued after the round due to an appeal, the Base HP value and all robots' HP of the losing team is set to zero, and the opposing team's Base HP and robots' HP remain at the amount when the round ends.</li> </ul>

The penalty system used throughout the competition consists of the five warnings described above. Some violations may immediately bring on a Level 4 or Level 5 Warning, whereas some may gradually upgrade from a Level 1 Warning. Level 1 Warning, Level 2 Warning, Level 3 Warning and Level 4 Warning are not grounds for a team to file an appeal. If teams file an appeal, the Chief Referee will directly dismiss it. During a match and before issuing a Level 4 or Level 5 Warning, the Head Referee will announce the

warning to the participants via headsets. After the announcement (about 10 seconds), the Head Referee sends the ejection order of the robot through the Referee System. The ejection order does not take the status and position of the robot into consideration. Team members must obey the Level 4 or Level 5 Warning issued by the Head Referee.

## 6.5.2 Three-minute Setup Period

Before the three-minute setup period of each round begins, both teams must wait at the area where robots are placed. Side Referees will check that both teams are prepared and then inform the Head Referee. The Head Referee will announce that both teams can enter the Battlefield. Participants need to move robots to the gate of the Battlefield. Side Referees will open the gate and guide participants to enter. When the gate open, the setup period countdown begins.

During the three-minute setup period, teams must follow specifications and if violating, they will get the penalties as shown below. All penalties for violations occurring during the setup period will be executed after the start of the match.

Table 6-7 Specification and Violations and Penalties During the Three-minute Setup Period

Specification	Violations and Penalties
The number of Pit Crew per team cannot exceed 14.	The referee will issue a verbal warning to any team that has more than 14 Pit Crew. Extra member must leave the Competition Area. If three verbal warnings are not heeded, the violating team will lose the round.

Specification	Violations and Penalties
<p>Pit Crew from both teams place their ground robots in their own Starting Zone to inspect whether the referee system equipment that directly connects to the robots operates normally. Moving within their own Starting Zone is allowed. Before the round begins, ground robots cannot leave their own Starting Zone, transform beyond their maximum initial size and fire projectiles in advance. The Referee System will lock the keyboard for the last five seconds of the twenty-second referee system initialization period. Therefore, at this time, Operators cannot use their keyboards. If the Operator controls the robot to leave the Starting Zone or transform beyond its maximum initial size before the keyboard is locked and fails to make it return to the Starting Zone or restore to its initial size due to keyboard lock, the Referee will issue and enforce penalties according to the corresponding violation regulations after the start of the match.</p>	<ul style="list-style-type: none"> <li>● If a ground robot leaves its own Starting Zone, transforms beyond its maximum initial size or fires projectiles before the match starts, it will be deemed as cheating and the Referee will issue a verbal warning. If three verbal warnings are not heeded, the Referee will issue a Level 2 Warning to the violator after the start of the march.</li> <li>● If a robot leaves its own Starting Zone and has plenty of time to return to the Starting Zone, or a robot has jumped the gun for a long distance, but the Operator refuses to obey the Referee's warning and does not control the robot to return to the Starting Zone before the start of the match, the Referee will issue a Level 4 Warning to the violating robot. The actual situation is determined by the Head Referee and Chief Referee.</li> </ul>
<p>Aerial can be adjusted within the Landing Pad, and the Aerial Safety Rope should be connected as required. Propellers cannot be turned on and projectiles can only be fired into the Projectile Storage Bag. After the match begins and 100 points of Energy accumulated, the Aerial Gimbal Operator may choose to start the Launching Mechanism to fire projectiles.</p>	<ul style="list-style-type: none"> <li>● If Aerial leaves the Landing Pad, launches projectiles or rotates its propellers in the Landing Pad within the Three-minute Set-Up Period, it will be deemed as cheating and the Referee will issue a verbal warning. If three verbal warnings are not heeded, the Referee will issue a Level 2 Warning to the violator.</li> <li>● If Aerial starts its propellers and flies off the Landing Pad, it will be ejected from the Competition Area and Pilot, Aerial Gimbal Operator and Projectile Supplier need to return to the Pit Area.</li> </ul>

Specification	Violations and Penalties
	<ul style="list-style-type: none"> <li>● If Aerial is adjusted or repaired outside the Landing Pad, the Referee will issue a verbal warning. If three verbal warnings are not heeded, the violating Aerial will be banned from this round.</li> <li>● Aerial that does not have an Aerial Safety Rope attached as required is not allowed to play in this round.</li> </ul>
<p>In the Three-minute Setup Period, pit crew will mount a Sentry on the main structure of the Sentry Rail, and Sentry must be steadily fixed or operated on the Rail.</p>	<p>If the fixation becomes unstable and Sentry may fall to the ground in the Three-minute Setup Period, the team members need to solve the installation problem at the request of the Referee. Otherwise, the faulted Sentry will not be allowed to play. The actual situation is determined by the Chief Referee.</p>
<p>Sentry and Aerial must empty their projectiles in the first round of the match until they can no longer fire projectiles. In other rounds of the same match, they can keep projectiles. Other robots must empty their projectiles until they can no longer fire projectiles.</p> <hr/> <div style="display: flex; align-items: flex-start;">  <p>In each round of a match, staff will distribute 500 shoots of 17 mm projectiles to the Projectile Supplier of both teams, who can choose to supply their Aerial.</p> </div>	<ul style="list-style-type: none"> <li>● Aerial or Sentry that does not empty projectiles as required is allowed to play in this round.</li> <li>● Any ground robot that does not empty projectiles as required will be ejected before the start of the match.</li> </ul>
<p>Pit Crew cannot pick up projectiles found on the Battlefield and supply to their own robots.</p>	<ul style="list-style-type: none"> <li>● If a Pit Crew Member picks up a projectile on the Battlefield, the Referee will issue a verbal warning. If three verbal warnings are not heeded, the Referee will issue a Level 2 Warning to the violator.</li> <li>● If a Pit Crew Member personally picks up a projectile and supplies a robot, the Referee will disqualify the robot.</li> </ul>

Specification	Violations and Penalties
	<ul style="list-style-type: none"> <li>If a Pit Crew Member supplies projectiles that are unofficial RM2019 projectiles, the violating party will be disqualified.</li> </ul>
<p>Pit Crew must ensure that their robots work safely and will not injure any person in the Battlefield.</p>	<p>If a robot injures on-site personnel due to firing projectiles, losing control or malfunction, the violating party will be punished as lose for the round. The actual situation is determined by the Chief Referee.</p>
<p>During the last 30 seconds of the Setup Period, all robots on the Battlefield must be powered on. At the same time, Referees will instruct Pit Crew to leave the field.</p>	<p>Pit Crew that does not leave the Battlefield will receive verbal warning and be reminded to power on their robots as soon as possible.</p>
<p>At the end of the Setup Period, Pit Crew from both teams must return to their designated area outside the Battlefield.</p>	<p>At the end of the Setup Period, any Pit Crew who fails to leave the Battlefield will be ejected and the team is not allowed to have other substitute members to enter the Competition Area in the remaining rounds of the match. If the ejected Crew Member does not obey and remain on the Battlefield, the team will be punished as lose for that round. The actual situation is determined by the Head Referee's on-site penalty.</p>
<p>Fully automated Sentry can only be adjusted via remote controller before the match and during the Setup Period. When the match starts, participants can use remote controller. During the Setup Period, participants must place the Sentry remote controller in the designated area of the Battlefield entrance after completing the preparatory work.</p>	<p>If a remote controller is used for Sentry during a match, it will be deemed as cheating once confirmed by the Head Referee or through investigation. All matches that Sentry uses a remote controller will be punished as lose.</p>

## 6.5.2.1 Technical Timeout

### 6.5.2.1.1 Official Technical Timeout

During the Setup Period, if the Referee System, Operator equipment or other modules related to the Referee System fails to work properly, the Head Referee can announce an Official Technical Timeout and suspend the setup countdown.

Table 6-8 Malfunctions

Rule	Description
1	Official equipment inside the Operator Room malfunctions.
2	During the Setup Period of the first round, the Referee System module on the robot fails. For example, the robot cannot normally transfer the image back to the Operator Room, or connect to the Referee System server.
3	Structural damage or malfunction of key Battlefield Components (Base cannot normally open shield, Base armor module shifts, drops or cannot detect hit damage, Power Rune cannot be triggered by normal hit, Aerial Safety Rope breaks or is worn out, and Projectile Supplier cannot provide projectiles, etc.)
4	Any other situations requiring an Official Technical Timeout determined by the Head Referee.

Teams should follow specifications as shown below:

- An Official Technical Timeout may only be implemented after an Operator Room Technician or Field Technician reports to the Head Referee. Pit Crew cannot request an Official Technical Timeout.
- If Rule 2 occurs during the Setup Period of the second round or later rounds, the damage will be considered incidental and an Official Technical Timeout will not be permitted. In these situations, it is too hard to determine whether the malfunctions were caused by the Referee System modules, a failure in the robot's mechanical or electrical system design, or operational mistakes made in previous matches. However, a Field Technician will provide backup Referee System modules, and the team can request a Team Technical Timeout to repair their robots.
- During an Official Technical Timeout, the team members can only cooperate with the technicians to eliminate the faults of the relevant referee system modules and cannot repair other faults. They must leave the Battlefield when the Referee System has been repaired.

#### 6.5.2.1.2 Team Technical Timeout

If the mechanical structure of all robots, software system or equipment like keyboard and mouse that is brought to the Operator Room fails to work properly, teams can request a Team Technical Timeout from the Head Referee during the setup period. Pit crew can use the Timeout to enter the Battlefield to repair their robots. Team members can only adjust their own robots in the Starting Zone or Landing Pad.

During RM2019 Regional Competition and International Regional Competition, each team has one 1-minute Technical Timeout, one 2-minute Technical Timeout, and one 3-minute Technical Timeout. Teams that have won the regional competition Excellent Aesthetic Design Award (Team Award) and the Annual Excellent Aesthetic Design Award (Team Award) will also be rewarded with an opportunity for a two-minute technical timeout (only valid during the competition). Once all Team Technical Timeout requests

are used, the team can no longer request.

When requesting Team Technical Timeout, teams must follow specifications and if violating, they will get the following penalties:

Table 6-9 Team Technical Timeout Specification and Violations and Penalties

Specification	Violations and Penalties
<p>Any request for a Team Technical Timeout must be submitted by the team Captain to a Side Referee or Operator Room Referee, with the length of the Timeout requested and the reason being clearly stated. The Head Referee announces the Timeout after confirming with other referees. The Setup Period countdown is paused at that time.</p>	<p>The Head Referee will only accept requests for Technical Timeouts raised by the team Captain.</p> <hr/> <p> The person who wears the Captain armband will be seen as the team Captain.</p>
<p>The Head Referee will inform both teams of the Team Technical Timeout regardless of which team requests. Pit crew from both teams can enter the Battlefield to repair their robots during this time. Only the team that requests the Timeout will expend one of its chances to timeout. During the last 20 seconds of the Timeout, referees will remind team members to leave the Battlefield. When the Timeout expires, pit crew must leave the Battlefield.</p>	<p>Any Pit Crew Member who does not leave the Battlefield will be ejected, and in all remaining rounds of the match, the team cannot have other substitute members enter the Competition Area. If the ejected crew member fails to comply and still remains on the Battlefield, the team will immediately be punished as lose for the round.</p>

Specification	Violations and Penalties
<p>When a Team Technical Timeout is initiated and confirmed by the Head Referee, the team uses up one of its allotted Timeouts regardless of the premature end of the Timeout. For example, if a team initiates a two-minute Team Technical Timeout but only uses dozens of seconds to maintain their robots, the full two-minute Team Technical Timeout is still deducted. At this point, the Referee will continue the Technical Timeout countdown or end prematurely when he confirms that both teams are ready. Additionally, if a team is granted a Team Technical Timeout but does not enter the Battlefield, it still uses up one of its Timeouts.</p>	-
<p>The team that calls for a Technical Timeout must do so before the last 15 seconds of the setup period. Between the last 15 seconds of the setup period until the end of the official round, a Technical Timeout cannot be called.</p>	-
<p>To ensure that subsequent matches begin on time, only one Team Technical Timeout is allowed per setup period. This Timeout is granted to the team that successfully places a request first. Technical Timeout usage is recorded in the Match Results Confirmation Form. The type of Technical Timeout is determined by the Head Referee based on the request of the team. The team captain cannot dispute the type of Technical Timeout when signing the form and the Technical Timeout process may not be used as a basis for appeals after the match.</p>	-

### 6.5.3 Referee System Initialization Period

After the 3-minute setup period, the match enters a twenty-second Referee System Initialization Period.



During the initialization, the competition server will automatically detect the status of client connection, the robot referee system module the competition elements, etc. If the status does not meet the requirements of the start of the round, such as an offline client, robot, or Battlefield Component, the countdown will be suspended. At this time, only the RMOC staff and a pit crew member of the team can enter the Battlefield to check the cause of the malfunction. Teams cannot request a Team Technical Timeout during the Referee System Initialization Period. After repairing malfunctions, the Referee resumes the initialization, and the countdown continues. The competition server will restore the HP of all robots, ensuring that all robots have full HP when the round officially begins.

During the Referee System Initialization Period, Operators (except Aerial Operator) can only stay in the Operator Room and Pilots can only in the Pilot Room.

## 6.5.4 Seven-minute Match Round

After a round begins, all Operators from both teams must stay in their Operator Room, Projectile Supplier must stay at the designated area next to the Pilot Room (see [Figure 5-37](#)), and other Pit Crew must watch the match at the Pit Area next to the Battlefield.

For violations and penalties of Supplier Penalty Zone, please refer to [5.4 Supplier Penalty Zone](#).

For violations and penalties of Resource Island Penalty Zone, please refer to [5.6.1 Resource Island Penalty Zone](#).

### 6.5.4.1 Projectile Obtaining

When obtaining projectiles, robots must follow specifications and if violating, they will get the following penalties:

Table 6-10 Projectile Obtaining Specification and Violations and Penalties

Specification	Violations and Penalties
Robots may not obtain projectiles from Sentry or Aerial.	Robots that obtain projectiles from Sentry or Aerial will be ejected from the round with a Level 4 Warning. The actual situation is determined by the Head Referee and Chief Referee.
During a match, robots may not directly collect projectiles from the ground.	Robots that collect projectiles from the ground will be ejected from the round with a Level 4 Warning. The actual situation is determined by the Head Referee and Chief Referee.

Specification	Violations and Penalties
Sentry and Hero cannot directly collect Projectile Containers from the Resource Island.	Sentry or Hero illegally collecting Projectile Containers will be ejected from the round with a Level 4 Warning. The actual situation is determined by the Head Referee and Chief Referee.
Engineer can only grab one Projectile Container at a time at most or only projectiles from one Projectile Container at a time. Only when one Projectile Container completely leaves the groove of the Resource Island, can the next Projectile Container be taken.	When Engineer grabs more than one Projectile Containers at a time or obtain projectiles from more than one Projectile Container at a time, it will be issued a Level 2 Warning for the first offense. If it violates again, the Referee will issue a Level 4 Warning. The actual situation is determined by the Head Referee and Chief Referee.

## 6.5.4.2 Collision and Getting Stuck Together

### 6.5.4.2.1 Collision

Collision refers to an occasion during a match when two team's robots collide with each other because of poor control by their operators. A robot may not use any of its structures to collide with the enemy's robots, regardless of whether the opposing robots have already been defeated. When a Battlefield component leaves the ground of the Battlefield and connects with a robot, it is considered part of the robot.

Teams can fire projectiles that meet the firing speed requirements at any part of the opposing team's ground robots. If the attack causes bending to any mechanical structure, damage of the VTM or circuit of the robot, this will be considered incidental damage and is not seen as basis for collisions or other types of penalties. However, if the Referee System module is damaged by projectile, technicians will provide backup modules.

Referees will decide the penalty as shown below for the culprit of such an occasion based on the actual contact that takes place and the impact the crash has on the match.

#### Violations and Penalties:

- If a robot intentionally touches and crashes into the opposing team's robot, the Referee will consider it plain collision and issue a Level 1 Warning.
- If a robot intentionally and rapidly crashes into the opposing team's robot or pushes the opposing team's robot to move, affecting its normal movement, the referee will consider it violent collision and issue a Level 2 Warning.
- If a robot intentionally and rapidly crashes into the opposing team's robot, pushes the opposing

team's robot to move for a long distance or affects its normal movement for a long time, the referee will consider it violent collision and issue a Level 3 Warning.

- If a robot intentionally, directly, rapidly, and repeatedly crashes into the opposing team's robot or a robot intentionally crashes into the opposing team's robot and knocks it a far distance, affecting its normal movement, the referee will consider it severe and violent collision and issue a Level 4 Warning. The actual situation is determined by the Head Referee and Chief Referee.



To ensure that Sentry is fully capable of moving along its Rail, any part of a robot that attacks the opposing team's Sentry (including a defeated one), either intentionally or unintentionally, will be deemed as violation and be penalized.

As for the penalty of colliding with a defeated robot (not including slowly pushing away a defeated robot because it blocks the road), the Referee will issue a Level 1-4 Warning on the violating robot or the team according to the above penalty criteria.

#### 6.5.4.2.2 Getting Stuck Together

Getting stuck refers to an occasion in a match when one team's robot cannot avoid the other team's robot. When two robots get stuck together during a match, the Referee will notify the two Operators to take appropriate actions to detach the robots. The two Operators must cooperate with the Referee's instructions and perform the requested operations. A robot must not get stuck together with any other robot due to active interference, blocking or collision.

Referees will decide the penalty as shown below for the culprit based on the actual contact that takes place and the impact the crash has on the match.

Violations and Penalties:

- If any part of a robot gets stuck together with any part of the opposing team's robot due to interference, blocking or collisions for T second(s), affecting the normal movement of the opposing robot, the Referee will issue a Level X Warning.

T Second(s)	Level X Warning
T < 10	1
10 < T < 30	2
30 < T < 60	3
T > 60	4

- If any part of a robot gets stuck together with any part of the opposing team's robot due to interference, blocking or collisions for a long period (longer than 60s), affecting the normal movement of the robot, and causing severe damage to the structure of the robot, or if an ejected robot remains sticking together with any part of the opposing team's robot, affecting the normal movement of the robot, the

Referee will issue a Level 5 Warning. The actual situation is determined by the Head Referee and Chief Referee.

If a robot gets stuck to a defeated robot, the Referee will issue a Level 1 to Level 4 Warning according to the above penalty criteria.

### 6.5.4.3 Transformation and Interaction

When transforming and interacting, robots must follow specifications and if violating, they will get the following penalties:

Table 6-11 Transformation and Interaction Specification and Violations and Penalties

Specification	Violations and Penalties								
Robots are prohibited from intentionally separating into sub-robots or sub-systems that are connected with flexible cable. Robots cannot intentionally cast off or launch their own parts.	A robot that separates into sub-robots or sub-systems or intentionally casts off its own parts will receive a Level 4 Warning.								
A robot may block at most four Armor Modules with each other when it is rescuing its own side's robot. A robot cannot cover its Armor Module by transforming or getting stuck together to its own side's robot for long periods in order to avoid attacks from the opposing team's robots.	During the process of rescuing, according to the blocking duration and the purpose of getting stuck together for T second(s), the Referee will issue a Level X Warning. The actual situation is determined by the Head Referee and Chief Referee.								
	<table border="1" style="width: 100%;"> <thead> <tr> <th style="background-color: #cccccc;">T Second(s)</th> <th style="background-color: #cccccc;">Level X Warning</th> </tr> </thead> <tbody> <tr> <td style="background-color: #cccccc;">T &lt; 3</td> <td style="background-color: #cccccc;">1</td> </tr> <tr> <td style="background-color: #cccccc;">3 &lt; T &lt; 10</td> <td style="background-color: #cccccc;">2</td> </tr> <tr> <td style="background-color: #cccccc;">T &gt; 10</td> <td style="background-color: #cccccc;">3</td> </tr> </tbody> </table>	T Second(s)	Level X Warning	T < 3	1	3 < T < 10	2	T > 10	3
	T Second(s)	Level X Warning							
	T < 3	1							
	3 < T < 10	2							
T > 10	3								
According to the robot's blocking of its own Armor Module by deformation to avoid other robot's attack for T seconds, the referee will issue an X-level warning to the offending party. The actual situation is determined by the Head Referee and Chief Referee.									
<table border="1" style="width: 100%;"> <thead> <tr> <th style="background-color: #cccccc;">T Second(s)</th> <th style="background-color: #cccccc;">Level X Warning</th> </tr> </thead> <tbody> <tr> <td style="background-color: #cccccc;">3 &lt; T &lt; 10</td> <td style="background-color: #cccccc;">1</td> </tr> <tr> <td style="background-color: #cccccc;">T &gt; 10</td> <td style="background-color: #cccccc;">2</td> </tr> </tbody> </table>	T Second(s)	Level X Warning	3 < T < 10	1	T > 10	2			
T Second(s)	Level X Warning								
3 < T < 10	1								
T > 10	2								

Specification	Violations and Penalties
Robots are prohibited from using sticky materials like 3M tape on its Projectile Grabbing Mechanism for projectiles.	<ul style="list-style-type: none"> <li>● A robot equipped with sticky materials 3M tape cannot pass the pre-match inspection.</li> <li>● A robot that has passed the pre-match inspection but uses sticky materials to pick up and drop projectiles during the match will be considered cheating. All rounds in which the violating robot participated will be punished as lose.</li> </ul>
None of the robot's moving mechanisms may cause damage to the core Battlefield Components (Base, Power Runes, Assistive Column, Sentry Rail, and Projectile Depot) on the Battlefield.	Once a robot causes damage to the Battlefield Components, the Referee shall confirm the damage and end the match, assessing a loss for the violating team.

#### 6.5.4.4 Rescue and Revival

After a robot is defeated (excluding robots ejected by the referee system server), its own side's robot can rescue it to the team's Restoration Zone. It will automatically revive after completing the revival process. (please refer to [4.4 HP Recovery and Revival](#))

When rescuing and reviving, robots must follow specifications and if violating, they will get the following penalties:

Table 6-12 Rescure and Revival Specification and Violations and Penalties

Specification	Violations and Penalties						
The opposing team's robots may launch projectiles at the rescuing robots, but they cannot block or crash into these robots.	<p>If any part of a robot intentionally and rapidly crashes into robots involved in a rescue or revival process, briefly affecting the process, or interferes with the opposing team's robot for T seconds, the Referee will issue a Level X Warning. If causing severe physical damage that the rescuing robots cannot operate, the Referee will issue a Level 5 Warning. The actual situation is determined by the Head Referee and Chief Referee.</p> <table border="1"> <thead> <tr> <th>T Seconds</th> <th>Level X Warning</th> </tr> </thead> <tbody> <tr> <td>T &lt; 3</td> <td>2</td> </tr> <tr> <td>3 &lt; T &lt; 10</td> <td>3</td> </tr> </tbody> </table>	T Seconds	Level X Warning	T < 3	2	3 < T < 10	3
T Seconds	Level X Warning						
T < 3	2						
3 < T < 10	3						

Specification	Violations and Penalties	
	T > 10	4
The rescuing robot cannot grab any Referee System module of the rescued robot.	-	

### 6.5.4.5 Exception Handling

Below are exceptions and the corresponding handlings:

- If a robot breaks down after the pre-match inspection, it will be deemed as incidental damage and the competition continues. If a robot has been damaged in the first round of the match and there are safety risks like short circuit, it needs to be powered off immediately and leaves the Competition Area to avoid affecting the normal progress of the competition. The actual situation is determined by the Head Referee.
- When severe safety risks and exception of robots arise on the Battlefield (battery explosion, Aerial flying towards the Audience Area due to broken Aerial Safety Rope, stadium power outage, explosion of a compressed gas cylinder, or interpersonal conflict), the Head Referee will notify both teams through the Operator Room Referees after discovering and confirming the emergency, and slay all robots through the Referee System. The result of the round will be invalid. When safety risks or exception is eliminated, the round will restart.
- If there is a problem affecting the fairness of the competition between two parties during the competition, the referee will judge the treatment according to the actual situation.
- If the general Battlefield Components are damaged during a match (damage to the ground rubber, ground lighting, or Base lighting), the match will proceed normally. If there is structural damage or malfunction of key Battlefield Components (Base cannot normally open shield, Base armor module shifts, drops or cannot detect hit damage, Power Rune cannot be triggered by normal hit, Aerial safety rope breaks or is worn out), the Head Referee will notify both teams through the Operator Room Referees after discovering and confirming the emergency, and slay all robots through the Referee System. The result of the round will be invalid. The field technicians will enter the Battlefield to repair, and once the Components function normally, there will be a replay.
- If the Official Projectile Supplier goes wrong, the Head Referee will evaluate whether this affects the fairness of the match. If it does, the Head Referee will announce to the Pit Crew of both teams that the Referee System will slay all robots. The current round ends immediately, the result of the round will be invalid. When problems are solved, there will be a replay.
- If some Battlefield Components have logistic problem that is not caused by participants in the process of the match (hit Power Rune but HP gain is not triggered), the Head Referee will manually solve the

problem through the Referee System. If the problem cannot be solved manually is confirmed cannot be eliminated, the Head Referee will announce to the Pit Crew on both teams that the Referee System will slay all robots. The round ends immediately, the result will be invalid. When problems are solved, there will be a replay.



This process may cause delays, and the RMOC will not be held responsible for the impact of these delays.

- During a match, if there is structural damage or malfunction of key Battlefield Components that affects the fairness of the match and the Head Referee did not confirm and end the game in time, leading to the situation that a game that should have ended continues to proceed and has victory, the result of the round is deemed invalid once confirmed by the Chief Referee, and there will be one rematch.
- If there is a serious violation that obviously deserves a Level 5 Warning but the Head Referee did not confirm and execute in time, the result of the game will be invalid and a Level 5 Warning will be appended to the violating team once confirmed by the Chief Referee or through investigation after the match.

## 6.5.5 Severe Violation and Cheating

To ensure fairness and proper regulation of the competition, any cheating or severe violation by an individual or a team will lead to the disqualification from the competition. The team will be prohibited from participating in the RM2019 Season and receiving any awards. The results of any match participated in by this team are documented for their opponents' reference.

The following actions are considered a severe violation of rules.

Table 6-13 Severe Violation

Rule	Severe Violation
1	Violate rules mentioned in this document but refuse to accept penalties, for example ejected Pit Crew do not leave the Competition Area, intervene with the Referee, etc.
2	Refuse to leave the Competition Area immediately after the match ends, affecting the match process
3	Install explosives or other prohibited materials on robots
4	Team members use robots to crash into or attack people, creating safety risks
5	Team members purposely damage the opponent's robots, Battlefield Components and other related equipment

Rule	Severe Violation
6	Team members engage in a physical confrontation with the Referee, their opponents, or the audience
7	Team members do not cooperate when the RMOC is hearing an appeal
8	Other severe actions that go against the guidelines and spirits of the competition, and the penalties will be determined by the Head Referee and Chief Referee
9	Violation of local laws and regulations inside the Competition Area, Audience Area, or accommodation. In addition to being disqualified from the competition, the RMOC will fully cooperate with the relevant authorities to pursue appropriate legal action against the offender

The following actions are considered cheating:

Table 6-14 Cheating

Rule	Cheating
1	Change or damage the Referee System, or affect any measuring function of the Referee System through technical tricks
2	A robot's behavior is different from that exhibited during the pre-match inspection, such as change in size and the installation of the Referee System
3	Operator is not team member and robot is not made by the team
4	Manually operate a robot that is required to be fully automated
5	Use unofficial projectiles
6	Other behavior that violates the game spirit or is determined to be cheating by the Chief Referee

## 6.6 Post-Match Procedure

Members from both teams must power off all their robots and remove them from the Competition Area when the match is over. Teams are required to empty all projectiles from the robots in the designated area and then return to the Preparation Area.

### Violations and Penalties:

Once the match is over, if a robot has not emptied its projectiles, the robot will be detained in the Projectile Unloading Area.

### 6.6.1 Results Confirmation

During each match, the Head Referee assistant records the results, penalties, and the remaining HP of



the team's robots and Base for each round on a Match Results Confirmation Form. The Technical Timeout usage will be recorded in the Technical Timeout Form. Team Captain must go to the Referee Area to confirm the results at the end of a match and Technical Timeout usage. The Referee will not accept appeal requests between the rounds of an individual match.

Both teams must confirm the match results by signing the Match Results Confirmation Form in the Referee Area within five minutes after the match ends. If a team Captain does not turn up at the Referee Area to sign the Form or request an appeal, it is deemed that their team agrees with the match results written on the Form. Once the team Captain has signed the Form, all rights to an appeal are forfeited.

## 6.6.2 Appeal

Every team has the right to appeal during each Regional Competition, Wild Card Competition, International Regional Competition, and the Final Tournament. However, appeals cannot be accumulated across competitions. If an appeal is successful, the appeal right reserves; otherwise, one appeal right is consumed. When all rights are exhausted, the RMOC will not accept any appeal from the team. When processing an appeal, an Arbitration Commission, which is made up of Chief Referee and heads of the RMOC, will be formed. The Arbitration Commission makes the final decision on all appeals.

If the result of an appeal is "Result Determined by a Rematch", both teams can appeal again after the rematch. In this scenario, if the previous team that made the initial appeal wants to appeal again (known as a "continued appeal"), this will consume the team's appeal right regardless of the appeal results. Due to potential delays to the competition schedule, this "continued appeal" must be initiated by both the Captain and Supervisor within five minutes after the match ends (both sign on the Appeal Form at the same time). The appeal process for a "continued appeal" is also simplified. The time for the submission of evidence and materials being shortened to within 30 minutes of the appeal. The RMOC will announce the result of the appeal in the Appeal Form within 60 minutes of the continued appeal.

### 6.6.2.1 Appeal Process

Teams that filing an appel need to follow procedures as shown below:

1. Within five minutes after the round ends, the Captain submits an appeal to the Chief Referee in the Referee Area and signs an Appeal Form. After five minutes of the end, any appeal will be deemed invalid. No appeal can be initiated before or during the match.
2. The Chief Referee checks whether the appeal can be processed.
3. If either side needs to collect evidence or defense materials for a period of one hour, the materials will need to be submitted to the Arbitration Commission, which will further communicate with the players involved in the appeal. If neither side needs to collect evidence or defense materials, go directly to the next step.

4. After the Chief Referee has accepted the appeal, Event Staff will invite Captain from both teams to meet in the Arbitration Room. If the team that made the appeal requests a robot inspection, the Arbitration Commission will transfer all robots from both teams to the Arbitration Room for immediate inspection. Each team can only send three members to the Arbitration Room, and one must be either the Captain, OPM, key member or Supervisor. The presence of the team Captain or the project manager is mandatory.
5. The Arbitration Commission makes a final decision. Both Captains sign the Appeal Form to confirm the decision. Once signed, both teams can no longer question the appeal result.

### **6.6.2.2 Appeal Validity**

Teams need to file an appeal within the validity period and below are different validity periods of different stages:

- **Appeal Request:** Appeals must be made within five minutes after the end of each match and recorded on the Appeal Form. The Arbitration Commission will not accept any appeal requests that exceeds the validity period.
- **Attendance to the Arbitration Room:** Both teams must arrive at the Arbitration Room within 30 minutes after receiving a notification from the Arbitration Commission. An absent team is deemed to give up their right to an appeal and must accept any decision made by the Arbitration Commission. If more than three members of a team enter the Arbitration Room or the identity of attendees do not meet the requirements, the team is also considered to give up their right to an appeal.
- **Submission of Evidence and Materials:** A team must submit evidence and materials within 60 minutes after requesting an appeal, and the Arbitration Commission will not accept any new materials beyond this 60-minute limit.

### **6.6.2.3 Appeal Material**

Appeal material that teams submit must follow the following specifications:

- **Types:** The Arbitration Commission only accepts materials stored on a USB drive or on a competing robot.
- **USB Drive:** The team must prepare video extracts and other document files as materials for their appeal. The RMOC will not assist in the collection of videos to maintain neutrality throughout the process.
- **Format:** Each video cannot exceed one minute in length be over 500 MB in size. The name of the video must indicate the specific round of the match and the time it was taken. Videos should be compatible with the latest version of Windows Media Player, photos must be in JPG format, and text documents must be in Word format and not exceed 1,000 words in length.

- Name: The name of each video and photo must not exceed 30 characters.
- Text: Each text document can only refer to one video or photo and must clearly state the name of the video or photo being referred to. The text document only needs to reflect the specific rules violation in support of the photo/video/robot(s).
- Evidence of Robot: The Arbitration Commission has the authority to isolate any relevant robot from both teams after an appeal has been made. These robots will not be isolated for more than three hours and will be returned to teams when the appeal is adjudicated.

#### **6.6.2.4 Appealing Decision**

The Arbitration Commission will release their final decision in the Appeal Form within three hours of the appeal being made. This decision has one of three possible outcomes: Original Result Upheld, Original Result Reversed, or Result Determined by a Rematch. Neither team may argue against the outcome of an appeal.

If the Arbitration Commission requests both teams to have a rematch, they will inform both teams of the time of this rematch. If both teams refuse to have a rematch, this appeal is discarded and both teams retain their right to appeal. A team that refuses a rematch is considered to have forfeited the match and lost.

## Appendix 1 Safety Instruction

Every team and all its members must fully understand and accept that safety is of paramount importance when competing at the RoboMaster 2019 Robotics Competition. To protect the rights and interests of all those who participate in the competition, as well as the rights and interests of the event organizers, everyone who enters the RoboMaster 2019 Robotics Competition must make the following commitments, uphold and abide by the following safety clauses in accordance with applicable laws and regulations:

1. All team members who register to take part in the RoboMaster 2019 Robotics Competition state that they are fully capable of civil conduct and can independently manufacture and operate robots. Prior to manufacturing robots, all team members will use materials provided by SZ DJI Technology Co., Ltd., carefully read registration rules, competition regulations, and other important documents containing rules and regulations related to the competition.
2. During the competition, all team members will ensure that their actions, including the manufacturing, testing, and use of robots will not cause any injury or damage to their teammates, members of the opposing team, referees, event staff, audience members, equipment or the Competition Area.
3. The team must ensure that the structural design of its robots will not hinder the safety inspections that take place prior to the commencement of the competition and agree to cooperate fully with the pre-inspection carried out by the RMOC.
4. The team guarantees that it will not use any internal combustion engines, explosives, high-pressure air products, or energetic materials.
5. Throughout the R&D, training as well as competition stage of the event, all team members must pay full attention to potential safety issues, and the team's Advisor must be responsible for instructing and supervising the team on safety issues.
6. The team must guarantee the safety of all robots. This includes ensuring the projectile launcher installed on the robots is safe, and that the projectiles will not cause any harm either directly or indirectly to any operator, referee, event staff or audience.
7. The team will take sufficient and necessary safety measures during R&D, training, and competition stage of the event regarding any hazardous situations that may occur. This includes but is not limited to: preventing the control system from becoming unstable; anticipating every potential operation prior to carrying out the operation to avoid wrongful operation or a collision between team members or between robots and team members; prohibiting team members from engaging in solo training and making sure that one or more people have been appointed as an emergency responder; wearing goggles and helmets; properly applying the lock function in the robot control system before engaging in debugging or adjustments; and equipping an emergency stop function on all robots.

8. The team will be held responsible for all accidents and losses that occur as a result from robot breaking down, drone losing control and any other unexpected circumstances.
9. The materials bought from or provided by the organizer of this competition (SZ DJI Technology Co., Ltd.) such as batteries and the Referee System must be used in accordance with the information contained in their user manuals. SZ DJI Technology Co., Ltd. will not be held responsible for any injuries that arise from the improper use of these materials. The team will be held responsible for any injuries caused to its own members or any other persons, as well as for damage caused to property arising from the production and operation of its robots.
10. All team members must remain in strict compliance with the laws and regulations of the country or region. All team members must also pledge that their robots will only be used for the RoboMaster competitions and that their robots will not be illegally modified or used for any illicit purpose(s).

## Appendix 2 Definition of RoboMaster Terminology

Type	Term	Definition
<b>Competition Name</b>	Warm-up Competition	A voluntary competition held in Shenzhen for teams to practice on the actual RoboMaster 2019 Battlefield.
	Chinese Regional Competition	The actual number of participants in the Mainland China teams and the regional distribution will determine the city the qualifiers will be held in. The results of the competition will determine the teams that advance to the RoboMaster 2019 Wild Card Competition and Final Tournament.
	International Regional Competition	The actual number of participating teams and the regional distribution of the teams from Hong Kong, Macau, Taiwan and Overseas will determine the city the qualifiers will be held in. The results of the competition will determine the teams that advance to the RoboMaster 2019 Final Tournament.
	Wild Card Competition	Competition for the last spots in the Final Tournament among teams that performed strongly, but did not qualify during Regional Competitions.
	Final Tournament	A week-long tournament for teams that win the grand prize and first prize of the Chinese Regional Competition or International Regional and teams that advance to the Wild Card Competition to determine the final champion of RoboMaster 2019.
<b>Robot Type</b>	Sentry	Autonomous robots that protect a team's Base.
	Hero	The main robot of the competition.
	Standard	Required robots with multiple uses throughout the competition.
	Aerial	A robot that provides an aerial view of the Battlefield and can fire 17 mm projectiles.
	Engineer	A robot built to provide assistance throughout the competition. One is required for each team.
<b>Staff Duty</b>	Supervisor	A professional representative of the university who mentors the team throughout the season.

Type	Term	Definition
	Advisor	Senior team members or professional engineers who guide the team in strategy, technology, and/or management.
	Captain	A student leader of the team to direct all technological and strategic aspects. Also serves as the team's contact person for the RMOC.
	Organizational Project Manager	Oversees the RoboMaster project by managing project schedules, budgets, and personal safety.
	PR Manager	Leads promotion of the robotics team and other competition-related projects.
	Team Member	Includes technical group, operations group, and operator group. The technical group is split into electronic (embedded system), algorithm (visual), mechanical, and hardware.
	Operator	A team member who controls a robot. Operators are categorized into those that operate ground robots, and those that fly airborne robots. Two operators are required to control airborne robots, an Aerial Gimbal Operator who controls the gimbal-mounted firing mechanism and a Pilot who manages the flight path.
	Pit Crew Member	Team members who enter the Staging Area and Competition Area.
	Head Inspector	An inspector who oversees all the pre-match inspections and makes the final decision on whether the team passes the pre-match inspection or not.
	Inspector	Assists with the pre-match inspection
	Chief Referee	Has the final decision and right of interpretation regarding competition rules. Issues penalties for severe violations of the rules. Has the right to issue additional penalties following an appeal.
	Head Referee	The main person responsible for controlling competition procedures and penalties.
	Side Referee	Executes competition procedures and penalties from their position around the perimeter of the Battlefield.
	Operator Room Referee	Executes competition procedures and penalties from their position in the Operator Room.

Type	Term	Definition
	Field Technician	Maintains the Battlefield by repairing it and other related elements. In addition, solves technical issues related to the Referee System.
<b>Technical Assessment</b>	Rules Exam	An exam that tests the understanding of and ability to interpret the content of the <a href="#">RoboMaster 2019 Robotics Competition Rules Manual</a> .
	Season Schedule	A Season Schedule that checks the team's realistic scientific abilities to prepare for the competition including its culture, project analysis, team structure, knowledge sharing ability, auditing systems, resource management, and business plan.
	Technical Proposal	A Technical Proposal that looks at how the team will design and develop their robots while conforming to the requirements, structural design, programming logic, ergonomics, scientific design, scientific practice improvement, innovation and aesthetic design.
	Mid-term Robot Assessment Video	A comprehensive look at whether the team's required robots meet all the minimum specifications required to show readiness for the competition.
	Final Robot Assessment Video	A comprehensive look at whether the team's robots meet all the minimum specifications required to show readiness for the competition.
	Referee System Exam	A test based on the <a href="#">RoboMaster 2019 Robotics Competition Referee System Specification Manual</a> to check understanding of the ability to install and use the Referee System.
	<b>Participating Team</b>	Team from Mainland China
Team from Hong Kong, Macau, Taiwan and Overseas		A team that received an invitation from the RMOC and qualified for the competition by successfully passing the registration and technical evaluations. The team is typically from universities outside of Mainland China.



Type	Term	Definition
	Chinese and Foreign Joint Team	A team that is qualified to participate in the competition after passing the registration and technical evaluations within the specified time. The team is typically from universities cooperatively-run by Mainland China and outside of Mainland China.
Technical Specification	Working Gas Pressure	The air pressure required for the main parts and gas pipes on a robot to work.
	Energy Source	Robots can be powered by electricity and air pressure.
	Optical Equipment	Robots taking action to reach goals by using different power and different colors at different visible wavelengths during a match.
	Visual Feature	Images used to assist robots.
HP	Initial HP	The HP of each robot set by the Referee System at the beginning of every round.
	Current HP	A real-time HP measurement of robots during a match.
	Maximum HP	The maximum HP available for each robot.
	HP Deduction	Damage caused by enemy projectiles that hit a robot's armor modules and base. HP deduction as the result of a penalty given by a referee is also included.
	Net Base HP	The difference between the remaining HP of the Base of both teams.
	HP Gain	Robots that are rewarded with additional HP by triggering core gears on the Battlefield or leveling up.
Referee System	Video Transmission Module	Captures live video from the camera and displays it on the operator's monitor in the Operator Room.
	Speed Monitor Module	Detects the initial speed of the projectile when it is launched by the robot's launching mechanism, and the Referee System deducts the robot's HP when the speed exceeds the limit.
	Armor Module	Comprised of armor plates and sensors this module Protects the internal workings of robots and detects projectile impacts to deduct HP accordingly.

Type	Term	Definition
	RFID Interaction Module	Communicates with RFID-enabled Battlefield Components (such as the Revival/Recovery Zone) to activate predetermined functions.
	Positioning System Module	Obtains the location of each robot on the Battlefield.
	Main Controller Module	Monitors all referee system modules and sends the real-time status of the robot to the server.
	Power Management Module	Controls the propulsion power, detects the power consumption of the chassis, and when the HP is 0, it automatically cuts off power supply for propulsion.
	Light Indicator Module	The length of the light bar indicates the level of HP, and the color of the light bar can be used to distinguish between the red/blue sides and the status of the robot.
<b>Functional Area</b>	Preparation Area	Includes the Inspection Area, Maintenance Area, and a rest area.
	Staging Area	Where qualified robots and participants prepare for a match.
	Competition Area	The formal tournament area that includes different functional areas, such as the competition field (also known as the Battlefield), referee area, stage, projectile management area, operator room, audience area, unloading area, and arbitration room.
	Competition Field (Battlefield)	The main competition site for participating robots. Includes a Starting Zone, Base Zone, Resource Islands, Landing Pads and Restoration Zone.
	Inspection Area	Where the participating robots undergo an inspection before competing.
	Maintenance Area	The only area where the robots' high-power devices can be repaired.
	Pit Area	The only area for players and robots to rest outside matches.
Referee Area	Where the Head and Chief Referees implement competition procedures, confirm participants' performance, process appeal requests, and carry out other official duties.	

Type	Term	Definition
	Red/Blue Operator Room	A room for robot and Aerial Gimbal Operators to control their robots during the competition.
	Pilot Room	An area for pilots to see and control the Aerial robot during the competition.
	Red/Blue Pit Area	The only area where non-operating pit crew members may sit and observe matches.
	Unloading Area	An area to unload projectiles from all robots after a match finishes.
	Arbitration Room	A room for representatives of the RoboMaster Organizing Committee and Chief Referee to deal with appeal requests.
	Red/Blue Entrance (Exit)	The pathway for participants to enter and exit the Competition Area.
<b>Battlefield Component</b>	Starting Zone	The only area where all ground robots have a three-minute setup period. This area includes the Base Zone and Sentry Rail.
	Base Zone	Where each team's Base is located.
	Base	The area that has core tools with 2000 HP, and is the main factor that determines which team wins.
	Sentry Rail	The only area the Sentry robot can access, includes a sliding rail and support frame.
	Bridge Top Platform	Located at the top plane of the bridge with Perimeter Wall on both sides to prevent robots from falling off the Bridge Top Platform. Robots occupying the Bridge Top Platform can receive accelerated barrel heat cool-downs and additional defensive capabilities.
	Bridge End Platform	Located at one of the exits of the bridges. These are areas where occupying robots can get a double barrel heat cool down rate.
	Bridge	Robots can occupy higher spots on the bridges for attack advantages, including the Bridge Top Platform that has the highest point and the Bridge End Platform. The bridge connects the Base Zone on one side and the Bridge End Platform on the other.

Type	Term	Definition
	Bunker	The key location in the main Battlefield where the barrel heat cool-down rate and the defensive capabilities of occupying robots will be improved.
	Resource Island	The most essential part of the Battlefield that consists of the projectile bank, Power Rune, and Assistive Column. The robot can get different quantities and different types of projectiles from the different projectile containers by ascending the Resource Island platform.
	Assistive Column	Fixed columns located on both sides of the Resource Islands. Robots can use the Assistive Columns to ascend to Resource Island and get projectiles from the projectile container.
	Supplier Penalty Zone	A Supplier zone is the Supplier Penalty Zone for the opposing team. A team entering the opposing team's Supplier Penalty Zone will receive penalties.
	Restoration Zone	Each team can use the Regeneration Points to initiate the recovery and revival of any of their robots that have exhausted their HP. Destroyed robots can also be brought here to be revived.
	Landing Pad	This is where the aerial robots of each team take off and land.
	Open Zone	Located at various points around the Battlefield, these are designed to test the power capabilities of a robot's chassis.
	Aerial Safety Rope	The Aerial Safety Rope is fixed to a steel cable and connected through pulleys that limit the Aerial robots flight range. All Aerials must be attached to a Safety rope via a slip ring before each match begins.
	Aerial Safety Rope Bracket	The compartment that ensures the correct height and tension of the steel cable.
Judging	3-Minute Setup Period	This period provides three minutes before a match for teams to enter the Competition Area and test their robots and equipment.
	7-Minute Round	A seven-minute period for teams to compete on the Battlefield.

Type	Term	Definition
	20-Second Referee System Initialization Period	A twenty-second period provided between the setup period and a round for connecting and checking the Referee System.
	Pass Card	Indicates that a robot has passed the pre-match inspection. Only robots with a Pass Card can enter the Staging and Competition Areas.
	Official Technical Timeout	During the setup period of the first round, technicians can request that the Chief Referee provide a Official Technical Timeout when the Referee System or other equipment in the Operator Rooms malfunction, or functional problems occur with critical equipment in the Battlefield.
	Team Technical Timeout	A pause in the competition that teams may request during the setup period to address specific needs. Teams are required to confirm the timeout with signatures before a Technical Timeout is accepted.
	Safety Hazard	On-site safety inspectors will handle possible safety hazards and problems that may occur during the competition.
	Robot Projectile Unloading	Robots are required to unload all projectiles during the setup period to ensure that both teams have the same number of projectiles and the competition remains fair.
	Rescue	After a robot dies on one team, a teammate can carry the dead robot to the Regeneration Point to resurrect the robot. After a certain amount of time, the dead robot will come back to life with full HP. This is called robot rescue.
	Violation	If a team member violates any rule stated in the rulebook, he/she will receive different level penalties from referees.
	Level 1 Warning	The operation interface of all Operators from the violating team will be blocked for three seconds upon receiving a warning.
	Level 2 Warning	<ul style="list-style-type: none"> <li>The operation interface of all Operators from the violating team will be blocked for five seconds.</li> </ul>

Type	Term	Definition
		<ul style="list-style-type: none"> <li>● The Referee System will automatically deduct 5% of the current maximum HP from all surviving robots (except Aerial and Base) of the violating team.</li> <li>● The violating robot will lose 2 points.</li> </ul>
	Level 3 Warning	<ul style="list-style-type: none"> <li>● The operation interface of the violating Operator will be blocked for ten seconds and other operators on the violating team for five seconds.</li> <li>● The violating robot will be deducted 50% of its current maximum HP and other surviving robots (except Aerial and Base) 5% of their current maximum HP.</li> <li>● The violating robot will lose 4 points.</li> </ul>
	Level 4 Warning	<ul style="list-style-type: none"> <li>● Ejected violating robots: In the round of the match, ground robots and Sentry are immediately slain by the Referee System (deduct all HP). Aerial will have its Launching Mechanism (including the loading mechanism and friction wheel) powered off and its VTM disconnected and must immediately land on the Landing Pad. Robots that are ejected cannot be revived.</li> <li>● Ejected Operators or other members: Members ejected by the Referee must immediately leave the Competition Area and no substitute Operator or Pit Crew Member is allowed for the remaining rounds of the match. The robot operated by the ejected Operator will be ejected at the start of all rounds of the current match. The amount of HP deducted from the ejection will be counted towards the other team's HP Deduction.</li> </ul>
	Level 5 Warning	<ul style="list-style-type: none"> <li>● If a Loss is issued before the match (not including the Three-Minute Setup Period) and the match has not yet started, the Pit Crew of the offending party must all leave the Competition Area. The Base HP and all robots' HP of the losing team are set to zero, while the opposing team's Base HP and robots' HP remain their maximum.</li> </ul>

Type	Term	Definition
		<ul style="list-style-type: none"> <li>● If a Loss is issued during a match (including the three-minute setup period), the Head Referee directly slays all robots of the offending team via the Referee System, and the round is over. The Base HP and all robots' HP of the losing team is set to zero, while the opposing team's Base HP and robots' HP remain at the amount when the round ends. At this point, Pit Crew of both sides must listen to the Referee's instruction to power off and move robots off the Battlefield.</li> <li>● If a Lose is issued after the round due to an appeal, the Base HP value and all robots' HP of the losing team is set to zero, and the opposing team's Base HP and robots' HP remain at the amount when the round ends.</li> </ul>
	Collision	An occasion during a match when two team's robots collide with each other because of poor control by their operators. Referees will decide the penalty for the culprit of such an occasion based on the actual contact that takes place and the impact the crash has on the match.
	Getting Stuck Together	An occasion in a match when one team's robot cannot avoid the other team's robot. Referees will decide the penalty for the culprit based on the actual contact that takes place and the impact the crash has on the match.
	Operator Desertion	If an Aerial operator or a ground robot operator leaves their Operator Room without permission, he or she will be penalized by the referee accordingly.
	Loss	A competing team will lose the round if they engage in an extremely serious violation of the rules or other forms of cheating. The referee determines this penalty in accordance with the rules that state it is applicable.
	Cheating	Forms of cheating are clearly set out in the rules. Referees will usually punish cheating by declaring the current round to have been lost by the offending team, with more serious forms of cheating leading to disqualification from the competition and its awards.

Type	Term	Definition
	Appeal	<p>If any of the teams hold different opinions regarding the results of a game, they can request for an appeal from the competition's RoboMaster Organizing Committee within a designated period. The number of appeals available to each team is subject to the stipulations set out in the rules. The team making the appeal must hand in supportive materials to the Appeals Panel, and members from the Appeals Panel as well as the Team Captains from both teams need to gather in the Arbitration Room to discuss the issue and come to a conclusion.</p>
	Result Confirmation	<p>Team Captains from both teams must go to the Referee Area to confirm they have no objections to the result of a match by signing off on the results within a designated period after each match.</p>



## Appendix 3 Technical Assessment Specification

All teams that compete in the RoboMaster 2019 Robotics Competition must complete a Technical Assessment in accordance with the requirements of the RoboMaster Organizing Committee and within the time specified. For the schedule of the RoboMaster 2019 Robotics Competition Technical Assessment, please refer to [1.1 Season Schedule](#).

The purpose of the Technical Assessment is to demonstrate the technical skills of a team, better prepare the team for the competition, and help in the future development. During the Technical Assessment, the RMOC encourages teams to be innovative and not stick to a rigid structure. Teams should also ensure that their report is clear and contains sufficient data. The RMOC does not accept Technical Assessment that is overly rigid or contains inaccuracies.

Technical Assessment will be graded according to certain requirements and the grade will be displayed in the registration system. The following shows the relation between scores and grades:

Table 6-15 Rating System

Score	Grade
$90 \leq X \leq 100$	A
$75 \leq X < 90$	B
$60 \leq X < 75$	C
$45 \leq X < 60$	D
$30 \leq X < 45$	E
$0 \leq X < 30$	F

### Technical Assessment Task and Requirement

In RoboMaster 2019 Robotics Competition, there are six Technical Assessment tasks in total: Rules Exam, Season Schedule, Mid-term Robot Assessment Video, Technical Proposal, Final Robot Assessment Video, Referee System Exam and Season Summary. Teams must complete the Technical Assessment task of corresponding stage before qualifying for further Assessment, Warm-up Competition, Regional Competition, International Regional Competition, Wild Card Competition and Final Tournament.

#### 1. Rules Exam

- Exam content: [RoboMaster 2019 Robotics Competition Rules Manual V1.0](#) and relevant competition rules
- Exam Form: 50 multiple-choice questions (generated randomly). Full mark is 100, with 2 marks for each question. The cut-off score is 90.

- The exam can be done more than one time within the effective time, and the minimum interval between the start time of the first and the second attempt is 40 minutes.
- The result of the exam is based on the last submission within the effective exam period.

## 2. Season Schedule

- Format: PDF document
- Font: Microsoft YaHei (Chinese) or Times New Roman (English) in size 10 File Size: no limit on the length, including diagrams (flowchart, table, etc.) Filename: College Name + Team Name + "First/Second Season Schedule"
- Submission Opportunity: 2 (The score of a second submission will receive a five-point deduction. For example, a second submission that receives a score of 90 will have five points deducted to a final score of 85 points.)
- Evaluation Requirement: The Season Schedule includes seven modules. Each of these modules has its own requirements. The details and requirements for the modules are as follows:

Table 6-16 Season Schedule Evaluation Requirement

Module	Content	Scoring Criteria	Score
<b>Competition Culture</b>	RM competition details and culture Core team culture	Clarity and accuracy	5
<b>Project Analysis</b>	The structure of each robot, all the other components that need to be finished (deadlines for actions), the capital and human resource requirements for each part	<ul style="list-style-type: none"> <li>● Content breadth and depth</li> <li>● Logical clarity and accuracy</li> <li>● Data clarity and accuracy</li> </ul>	25
<b>Team Structure</b>	Team's management structure	Reasonable structure	10
	Recruitment direction	Cooperativeness	
	Responsibilities of each role	Clarity of duties	
<b>Knowledge Sharing</b>	Open source forum materials, material manuals, knowledge sharing platform	Quality and quantity of information	20
	Procedures, document management software applications	Reasonable usage of open software	



Module	Content	Scoring Criteria	Score
	Training and self-learning processes	Reasonable study plan	
<b>Auditing System</b>	Task proposal, allocation, verification, evaluation, progress tracking and results acceptance system	Reasonable processes that are easily executable	15
<b>Resource Management</b>	Evaluation of resources available (budgeting, materials, and manufacturing resources)	Thoroughness of investigation	10
	Arrangement of manpower and schedule	Reasonable Planning	
	Work arrangements that take both schoolwork and competition tasks into consideration	Reasonable resource allocation	
<b>Business Plan</b>	<ul style="list-style-type: none"> <li>● Acquisition of resources and materials needed throughout the season Team sponsorship</li> <li>● Promotional plan</li> </ul>	Clarity and quality of plan	15
<b>Total</b>			100

### 3. Mid-term Robot Assessment Video

- Submission Format: Video + BOM Form
- Basic Requirement:
  - Complete at least the requirements for Hero or Engineer and submit the BOM Form of the corresponding robot.
  - Complete the requirements for Standard and submit the BOM Form.
- Submission Opportunity: 3 (The score of a second submission will receive a five-point deduction; the third a 10-point deduction. For example, the third submission that receives a score of 90 will have ten points deducted to a final score of 80 points.)
- Submission method:
  1. Upload the video to Youku and set an access password.
  2. Fill the BOM Form according to the template.
  3. Submit the video URL, access password and BOM Form through the registration system.
- Video Standard:

- A title that includes the college name and date/place of the recording must be displayed at the beginning of the video.
  - It is recommended to record the video in a place with sufficient lighting so as to best display every operation and movement.
  - For clarity, every process must include captions along with clear and accurate explanations.
  - The video must be concise and cannot exceed three minutes. Ensure the video is compact and well put together to save on assessment time.
  - Editing is allowed, but fraudulent operations are forbidden.
  - Videos must have a resolution of 720p or higher.
- Evaluation Requirement: Different items have different requirements and scores. Below is the specific requirements of each item.

Table 6-17 Mid-term Robot Assessment Video Evaluation Requirement

Item	Display Content	Criteria for Pass
<b>Engineer</b>	<ul style="list-style-type: none"> <li>● Complete movement</li> <li>● Obtain projectiles</li> <li>● Climb up projectile depot</li> </ul>	<ul style="list-style-type: none"> <li>● Can move normally</li> <li>● Can obtain projectiles</li> </ul>
<b>Hero</b>	<ul style="list-style-type: none"> <li>● Complete movement</li> <li>● Launch projectiles successively to targets one, three, and five meters away and calculate the hit rates</li> </ul> <hr/> <p style="text-align: center;"> Human assistance is not allowed.</p> <hr/> <ul style="list-style-type: none"> <li>● Climb a 15-degree slope and display the power consumption data in real time</li> </ul>	<ul style="list-style-type: none"> <li>● Can move normally</li> <li>● Can attack</li> </ul>
<b>Standard</b>	<ul style="list-style-type: none"> <li>● Complete movement</li> <li>● Launch 50 shoots of projectiles successively to targets one, three, and five meters away and calculate the hit rates</li> </ul> <hr/> <p style="text-align: center;"> Human assistance is not allowed.</p> <hr/> <ul style="list-style-type: none"> <li>● Climb a 15-degree slope and display the power consumption data in real time</li> </ul>	<ul style="list-style-type: none"> <li>● Not exceed the power limit in the process of display</li> </ul>

## 4. Technical Proposal

- Format: PDF document
- Font: Microsoft YaHei (Chinese) or Times New Roman (English) in size 10 File Size: Max. 8,000 words including diagram (flowchart, table, etc.)
- Content Requirement: Graphs and flowcharts that include adequate data, focus on key points, and demonstrate sound logic.
- File Name: College Name + Team Name + "First/Second/Third Technical Proposal"
- Submission Opportunity: 3 (The score of a second submission will receive a five-point deduction, and the third submission will receive a ten-point deduction. For example, a third submission that receives a score of 90 will have ten points deducted to a final score of 80 points.)
- Evaluation Requirement: The Technical Proposal includes eight modules. Each of these modules has its own requirements, scoring criteria, and score. The details and requirements for the modules are as follows:

Table 6-18 Technical Proposal Evaluation Requirement

Module	Content	Scoring Criteria	Score
<b>Requirement Confirmation</b>	From the rules and team's ability, determine task priorities and key technologies for winning matches.	Clarity and quality of technical requirements and specifications	10
<b>Structural Design</b>	Assemblies or component Project Proposal attached in the document appendix	Analysis of the quality, requirements, performance, material usage, component selection, and manufacturing method	20
<b>Programming Logic</b>	Show the program logic diagram for one of the robots	Logic accuracy, modularity, requirement fulfillment	10
<b>User-robot Interaction</b>	Use case description for one user-robot interaction design solution	Intuitiveness of design Optimization of user-robot interaction Quality	10
<b>Scientific Design Method</b>	Use case description of simulations combined with real-world implementations	Demonstration of theory-based design, comparison between simulation and real-world results	15

Module	Content	Scoring Criteria	Score
<b>Theory-based Improvement</b>	Use case description of practical improvement methods being applied to robots	Whether the experimental method is scientific, whether the data analysis is reasonable, whether the cause analysis is correct, whether the improvement method is effective, whether there are homemade debugging software and tools	15
<b>Sensor Selection</b>	Analyze the sensor selection of a car, the purpose of using visual and general sensors	Whether the selected sensor is rational and greatly improves the operating performance	10
<b>Innovation</b>	Use case description of innovative methods applied to robots	Whether innovations lead to better results	10
<b>Total</b>			100

- Based on a certain functional component, the analysis report can focus on the following aspects:

Table 6-19 Robot Design Evaluation Requirement

Item	Content	Scoring Criteria	Score
<b>Requirement Analysis</b>	Mechanism function, performance indexes and analysis under different working conditions. Sensor and actuator selection parameters	Quality of analysis, usage of dynamic simulation	30
<b>Design Drawing</b>	Taking one component as an example and show the engineering diagram (with STEP file)	<ul style="list-style-type: none"> <li>● Complete diagrams of 2D and 3D drawings</li> <li>● Reasonable dimensions, tolerance, label positions and consistent fonts</li> <li>● Reasonable materials, surface treatment</li> </ul>	20



Item	Content	Scoring Criteria	Score
<b>Material and Manufacturing Process</b>	Lists the materials selection, manufacturing techniques/cost, and plan to reduce costs for different batches	Selection of materials and accessories, labor cost calculations, rationale of manufacturing processes and costs, costs reduction plan	20
<b>Finite Element Analysis</b>	An FEM report for a certain component that includes: loading condition, meshing, Results Analysis, Optimization	Meshing and optimization method Topological optimization registration	30
<b>Total</b>			100

## 5. Final Robot Assessment Video

- Submission Format: Video
- Basic Requirement: Hero and Standard are required and other robots are optional.
- Submission Method: Upload the video to Youku, set an access password, and submit the video URL and password to the registration system.
- The video standard and submission opportunity are the same with the Mid-term Robot Assessment Video.
- Assessment Requirement: Different items have different requirements and scores. The following are the specific requirements for each item:

Table 6-20 Final Robot Assessment Video Evaluation Requirement

Item	Display Content	Criteria for pass
<b>Hero</b>	<ul style="list-style-type: none"> <li>● Launch projectiles successively to targets one, three, and five meters away and calculate the hit rate</li> </ul> <hr/> <div style="display: flex; align-items: center;">  <p>Human assistance is not allowed.</p> </div> <hr/> <ul style="list-style-type: none"> <li>● Climb a 15-degree slope and display the power consumption data in real time</li> <li>● A place reserved to install the Referee System</li> </ul>	<ul style="list-style-type: none"> <li>● Can attack</li> <li>● The power consumption should not exceed the limit during display</li> <li>● Equipped with a protective case, presentable appearance and no bare wires</li> </ul>

Item	Display Content	Criteria for pass
<b>Standard</b>	<ul style="list-style-type: none"> <li>● Complete movement</li> <li>● Launch 50 shoots of projectiles successively to targets one, three, and five meters away and calculate the hit rate</li> </ul> <hr/> <div style="display: flex; align-items: center;">  <p>Human assistance is not allowed.</p> </div> <hr/> <ul style="list-style-type: none"> <li>● Climb a 15-degree slope and display the power consumption data in real time</li> <li>● A place reserved to install the Referee System</li> </ul>	<ul style="list-style-type: none"> <li>● The Referee System installation positions meet the requirements</li> </ul>
<b>Engineer</b>	<ul style="list-style-type: none"> <li>● Complete movement</li> <li>● Obtain projectiles</li> <li>● A place reserved to install the Referee System</li> </ul>	<ul style="list-style-type: none"> <li>● Can obtain projectileS</li> <li>● The Referee System installation positions meet the requirements</li> </ul>
<b>Sentry</b>	<ul style="list-style-type: none"> <li>● Move along the Rail</li> <li>● The Launching Mechanism launches 50 shoots of projectiles successively to targets and calculate the hit rate</li> </ul> <hr/> <div style="display: flex; align-items: center;">  <p>Human assistance is not allowed.</p> </div>	<ul style="list-style-type: none"> <li>● Can move along the rail freely</li> <li>● Can attack</li> </ul>
<b>Aerial</b>	<ul style="list-style-type: none"> <li>● Display the flying ability of the Aerial</li> <li>● Launch 50 shoots of projectiles successively to targets after taking off and calculate the hit rate</li> </ul> <hr/> <div style="display: flex; align-items: center;">  <p>Human assistance is not allowed.</p> </div>	<ul style="list-style-type: none"> <li>● Can fly</li> <li>● Can attack</li> </ul>
<b>Full lineup display</b>	Clearly display the complete form of all robots and group photos of all team members	All robots of the team should be consistent in style, presentable in appearance and with no bare wires

## 6. Referee System Exam



- Exam content: Multiple-choice questions randomly selected from the RoboMaster database.
- Exam form: Full mark is 100. The cut-off score is 90.
- If the pass requirements have not been met within the valid time of the evaluation, repeat the completion of questions. Once several requirements are met, then it will immediately pass the review. The minimum interval between the start of the two questions is 20 minutes.
- The result of the exam is based on the last submission within the effective exam period.

## 7. Season Summary

- Format: PDF document
- Font: Microsoft YaHei (Chinese) or Times New Roman (English) in size 10
- File Size: Max. 8,000 words
- Content Requirement: Graphs and flowcharts that include adequate data, focus on key points, and demonstrate sound logic.
- Evaluation Requirement: The Season Summary includes four modules. Each of these modules has its own requirements, scoring criteria, and score. The details and requirements for the modules are as follows:

Table 6-21 Season Summary Evaluation Requirement

Module	Content	Scoring Criteria	Score
<b>Academic Innovation</b>	All competition-related patents, academic articles, and open-source documents	The quality and quantity of patents, articles and open-source documents	30
<b>Competition Analysis</b>	Analyzes problems that arise in each match and then finds a cause and solution	Comprehensiveness of analysis Adequacy of data Helpfulness of the summary	10
<b>Team Development</b>	Summary of the problems and challenges encountered throughout the season, plans to improve and develop the team		25
<b>Project Management</b>	Causes, data, and results of each improvement and iteration		35
<b>Total</b>			100

## Appendix 4 RM Online Product Education Discount

Product	Standard	Hero	Engineer	Sentry	Aerial	Discount
Development Board Type A	1	1	1	1	1	40% Off
Development Board Cables Package	1	1	1	1	1	
M3508 P19 Brushless DC Gear Motor	4	4	4	2	-	
C620 Brushless Motor ESC	4	4	4	2	-	
M3508 Accessories Package	1	1	1	1	-	
M2006 P36 Brushless DC Gear Motor	1	1	1	1	1	
C610 Brushless Motor ESC	1	1	1	1	1	
TB47D Battery	1	2	2	1	8	
6020 Gimbal Motor	2	2	-	2	2	
N3 Flight Control	-	-	-	-	1	
Guidance Package	-	-	-	-	1	

## Appendix 5 Pre-match Inspection Form

Category	Inspection Item	Description
<b>Robot Size &amp; Mass</b>	Initial Size(length * width * height)	<ul style="list-style-type: none"> <li>● Standard: 600 * 600 * 500 mm</li> <li>● Sentry: 500 * 500 * 600 mm (excluding the Light Indicator Module, Positioning System Module, and Positioning System Module Bracket)</li> <li>● Hero: 800 * 800 * 800 mm</li> <li>● Aerial: 1200 * 1200 * 800 mm (height)</li> <li>● Engineer: 800 * 800 * 800 mm</li> </ul>
	Expansion Size (length * width * height)	<ul style="list-style-type: none"> <li>● Standard: 700 * 700 * 600 mm</li> <li>● Sentry: 500 * 500 * 600mm (Distance from the lowest point of the robot to the upper surface of Sentry Rail must not exceed 450 mm)</li> <li>● Hero: 1200 * 1200 * 1200 mm</li> <li>● Aerial: 1200 * 1200 * 800 mm (height)</li> <li>● Engineer: 1200 * 1200 * 1200 mm</li> </ul>
	Mass	<ul style="list-style-type: none"> <li>● Standard: 20 kg (subtract the 3.7 kg of the Referee System)</li> <li>● Sentry: 10 kg (subtract the 2.2 kg of the Referee System)</li> <li>● Hero: 35 kg (subtract the 5.0 kg of the Referee System)</li> <li>● Aerial: 10 kg (subtract the 0.6 kg of the Referee System)</li> <li>● Engineer: 35 kg (subtract the 2.6 kg of the Referee System)</li> </ul>
<b>Robot Module</b>	Referee System Completeness	The Referee System modules should be complete (intact) and unmodified.
	Aerial Safety Module	<ul style="list-style-type: none"> <li>● The vertical Safety Rod of Aerial should be 300 mm higher than the top of the propeller and rigidly coupled to the robot body. The wire loop attached to the rod is used as a pull ring.</li> <li>● The safety rod and the pull ring can bear the Aerial's static weight. Connect the robot to the drawstring, raise it vertically by 0.05 meters, and let free fall once without significant deformation and damage.</li> <li>● Aerial must be fitted with fully enclosed propeller guards. Aerial hits the rigid plane at a horizontal velocity of <math>(1.2 \pm 0.1)</math></li> </ul>

Category	Inspection Item	Description
		<p>m/s without significant damage.</p> <ul style="list-style-type: none"> <li>● The propeller blades should not collide with the surface of a cylinder of any diameter when flying horizontally at a cylinder.</li> <li>● The lighting effects (e.g. brightness, flashing frequency) of the signal indicators must not interfere with the competition process. There should be no more than six indicator lights on the entire Aerial.</li> </ul>
	Armor Module	<ul style="list-style-type: none"> <li>● Only official mounts are allowed. They must not be modified or damaged.</li> <li>● The imaginary connection lines between the X-axis armor plates and Y-axis armor plates respectively should be perpendicular to each other and intersect the geometric center of a robot. X-axis and Y-axis armor modules allow a <math>\pm 50</math> mm deviation from the geometric center.</li> <li>● The weight-bearing surface and the armor plate mount must be firmly and rigidly connected, and the two screws of each mount must be installed.</li> <li>● The infinitely extended range of the lower edge <math>105^\circ</math> of Armor Module must not be covered and HP can be deducted normally. The service life of Armor Module is normal and sensors work well. Atmost one Armor Module of Engineer is allowed to be covered beyond 150 mm.</li> <li>● The top Armor Support Frame coupled with the front Armor Support Frame, and the impact surface top armor is angled at <math>15^\circ</math> to the horizontal plane. Any obstruction to the orthographic projection area of the Top Armor attack surface must not exceed 110 mm * 63 mm or the projection area should not exceed 3500 mm<sup>2</sup> for Standard and 120 mm * 74 mm for Hero or the projection area should not exceed 4500 mm<sup>2</sup>.</li> </ul>

Category	Inspection Item	Description
		<ul style="list-style-type: none"> <li>● The height of the lower edge of the armor before and after transformation must fall within 60-150 mm for Standard Robots, 60-400 mm for Engineers, and 60-200 mm for Hero.</li> <li>● For Hero and Engineer, the height difference between the lower edge of any two Armor Modules must not exceed 100 mm.</li> <li>● The projected vectors of the normal vectors of the armor module's stress-bearing surface on the XY plane must be equal to the positive/negative X axis and Y axis in the body coordinate system, respectively.</li> <li>● For Sentry, the maximum height below the upper surface of the rail shall not exceed 450 mm (including the entire light indicator module and the maximum extension size); the upper edge of the armor shall be within <math>\pm 100</math> mm from the upper surface of the track, and the impact surface and the horizontal plane shall be at a <math>75^\circ</math> angle.</li> <li>● The robot armor sticker must be consistent with the robot number with no obvious bubbles. Only one sticker can be attached to one piece of armor.</li> <li>● Any Armor Module should not actively move relative to the robot body's center of mass. For Hero, the relative position between the geometric center point of the four Side Armor Modules and the horizontal plane of the center axis of the barrel of any horizontal Launching Mechanism cannot be changed during the competition.</li> </ul>
	Power Inspection	<ul style="list-style-type: none"> <li>● The power curve should be normal.</li> <li>● A chassis should stop moving after its power is cut off.</li> <li>● Standard or Hero faces and abuts the vertical rigid plane (such as the wall), the remote controller pushes to the maximum rod amount, the robot accelerates for 20 seconds, and there is no blood-deduction due to exceeding the limit throughout the whole process.</li> </ul>

Category	Inspection Item	Description
	Main Controller Module	<ul style="list-style-type: none"> <li>● For the main control module screen, there can be no obstruction within 50 mm above the button, making it convenient for operation.</li> <li>● There should be no electromagnetic device that may interfere with the Main Controller Module within 70 mm of the “RoboMaster” logo located on the module.</li> <li>● The infrared receiver should not be blocked for the sake of convenience during manual connection to the server before each match.</li> <li>● Ensure that the upgrade interface is accessible for wire plug-ins.</li> </ul>
	Power Management Module	<ul style="list-style-type: none"> <li>● The indicators must not be blocked.</li> <li>● The power module should have good heat dissipation.</li> </ul>
	Light Indicator Module	<ul style="list-style-type: none"> <li>● The front main light bar and the top auxiliary light bar should be fully visible from at least one viewing angle.</li> <li>● Connection wires of the left and right auxiliary light bars are parallel to the ground.</li> <li>● The main light bar of Standard must be above the upper edge of the Armor Module.</li> </ul>
	RFID Interaction Module	When the card is swiped, the RF card on the ground can be detected normally.
	Speed Monitor Module	<ul style="list-style-type: none"> <li>● The projectile speed and rate of fire should be displayed (each robot must be capable of shooting using a remote control for the convenience of inspection).</li> <li>● Only Hero can be equipped with one 17 mm Launching Mechanism and one 42 mm Launching Mechanism.</li> <li>● The area covered by any obstruction on the light bar on each side of the speed measurement module must not exceed 1/5 of the original area of the light bar.</li> </ul>

Category	Inspection Item	Description
		<ul style="list-style-type: none"> <li>● There should be no large magnetic material or inducible magnetic material (e.g. iron barrel, motors, magnets) within 70 mm of the “RoboMaster” logo on the Speed Monitor Module.</li> <li>● Re-calibration should be completed every time it leaves the Inspection Area.</li> <li>● When the robot launches ten 17 mm projectiles or launches five 42 mm projectiles, the maximum speed difference detected by the speed measuring module shall not be more than 5 m/s.</li> </ul>
	Positioning System Module	<ul style="list-style-type: none"> <li>● The Positioning System Module should be installed horizontally with its top surface facing up, the front surface should be parallel with the frontal plane of the robot.</li> <li>● The above 145° range of the Positioning System Module should not be covered by conductors. Atmost 100 mm beyond one horizontal direction of Aerial is allowed to be covered.</li> <li>● After connecting the Inspection Area Base, the LINK indicator should flash green, and the SYS indicator should flash red.</li> </ul>
	Video Transmission Module	A robot should transmit pictures back normally.
Energy Source	-	<ul style="list-style-type: none"> <li>● Cylinder: Cylinder must have a valid conformity certificate or a steel plate. The plate should be viewable during the pre-match inspection and the certificate should be easily viewable.</li> <li>● The compressed gas pressure inside the cylinder must not exceed 20 Mpa. The cylinder used should have a nominal pressure of no less than 30 MPa. The working pressure must not exceed 0.8 Mpa. A double gauge constant pressure valve should be placed at the outlet of the cylinder.</li> </ul>

Category	Inspection Item	Description
		<ul style="list-style-type: none"> <li>● Working gas: Working gas must be non-flammable and non-toxic, such as air, nitrogen or carbon dioxide.</li> <li>● Cylinder certification: Cylinder must be designed and manufactured for the pressure condition for usage, and certified by the officially recognized test organization of the country of origin with a valid conformity certificate. The certificate should be easily viewable.</li> <li>● Pressure regulator: The constant pressure valve must be directly installed on the gas cylinder or gas tank.</li> <li>● Protection measure: Gas cylinder and gas pipe must be protected to prevent damage caused by rollover, collision and rotation from any direction, and moving parts failures. The container opening shall not be exposed in order to prevent damage caused by projectiles.</li> <li>● Location of gas cylinder and pipe: The gas cylinder should be installed in a way that it and the gas pipe will not touch the ground no matter how the robot rolls.</li> <li>● Cylinder installation: The cylinder must be safely mounted on the frame and ensure the container opening remains either level or upward. To fix to the frame, the container must have at least two fixed points, or one fixed surface that is more than 1/5 of its length.</li> <li>● Thermal insulation: The cylinder must be insulated from any possible heat sources by a barrier layer, such as a carbon fiber board or aluminum plate.</li> <li>● Gas Pipes and fittings: Gas pipes and fittings must be able to handle the system's maximum possible working pressure.</li> </ul>
<b>Strength</b>	-	Drop freely at a vertical height of 0.2 m three times without any damage to any position of the body.
<b>Aesthetic Design</b>	-	<ul style="list-style-type: none"> <li>● The lines of the robot are neat and not exposed. Exposure that is unavoidable requires line protection with materials such as drag chains and cable managers.</li> </ul>



Category	Inspection Item	Description
		<ul style="list-style-type: none"> <li>● There must be no materials that have an obvious influence on the appearance of the robot, such as washbasins, plastic bottles, corrugated paper, bed sheets, flesh-colored stockings, white foam boards, air cushion membranes, etc.</li> <li>● Fish nets should not be used as aesthetic design materials, unless necessary functional requirements exist.</li> <li>● The Red team robot's protective shell color can use red series, the blue team robot can use blue series, but the opposing team's color should not be used, to avoid confusion. Except for black and metallic colors, the number of other colors must not exceed two.</li> <li>● The surface glossiness of the case is required to be no more than 15 Gs.</li> <li>● The robot must have two school badges or team badges from their own side (one for each perspective). The school badges or team badges must be in a prominent position across the robot.</li> <li>● In a single robot advertising space, there are no more than two sponsor logos displayed and display of sponsors must be reported to the RMOC for approval.</li> </ul>
<p><b>Miscellaneous</b></p>	<p>-</p>	<ul style="list-style-type: none"> <li>● Only use dry batteries such as No. 1, No. 5, and No. 7 produced by reputable manufacturers or specified by the RMOC. In the 2019 Season, battery that is specified by the RMOC is produced by DJI.</li> <li>● The total battery capacity of Aerial should not exceed 600 Wh and that of other robots not exceed 200 Wh.</li> <li>● The supply voltage should not be higher than 48 V and there should be no risk of short circuiting.</li> <li>● Participants are forbidden from setting up wireless networks in the relevant areas (including but not limited to the Preparation Area, Inspection Area, Staging Area, and Competition Area).</li> </ul>

Category	Inspection Item	Description
		<ul style="list-style-type: none"> <li>● Each Operator can use at most one remote controller and each remote controller can only be targeted to one receiver. Only use remote controller that is specified by the RMOC. In the 2019 Season, remote controller that is specified by the RMOC is produced by DJI.</li> <li>● The laser beam from the laser sight must be red and the optical power consumption of the laser beam is less than 35 mW. The projection angle of the laser sight must not exceed 5° (i.e. the diameter of the laser spot perpendicularly projected by the laser sight on a vertical wall with a horizontal distance of one meter is less than 9 cm).</li> <li>● In addition to the laser sight, Engineers can be equipped with a visible light emitting device, and a fill light can be used to enhance the visual recognition feature when going to an island or acquiring a Projectile Container. Other ground robots must not be equipped with other obvious visible light emitting equipment.</li> <li>● A robot should not possess any Mechanism that may damage the Battlefield.</li> <li>● A robot should not possess any mechanisms that allow it to get stuck with other robots.</li> <li>● Do not project light onto the armor and do not install any device that interferes with the computer vision feature identification of the Armor Module by reflecting or refracting the light on both sides of the armor on the robot.</li> <li>● Standard can enter the official projectile supplier to complete the projectile supply action.</li> </ul>

**Appendix 6 Reference Drawing**









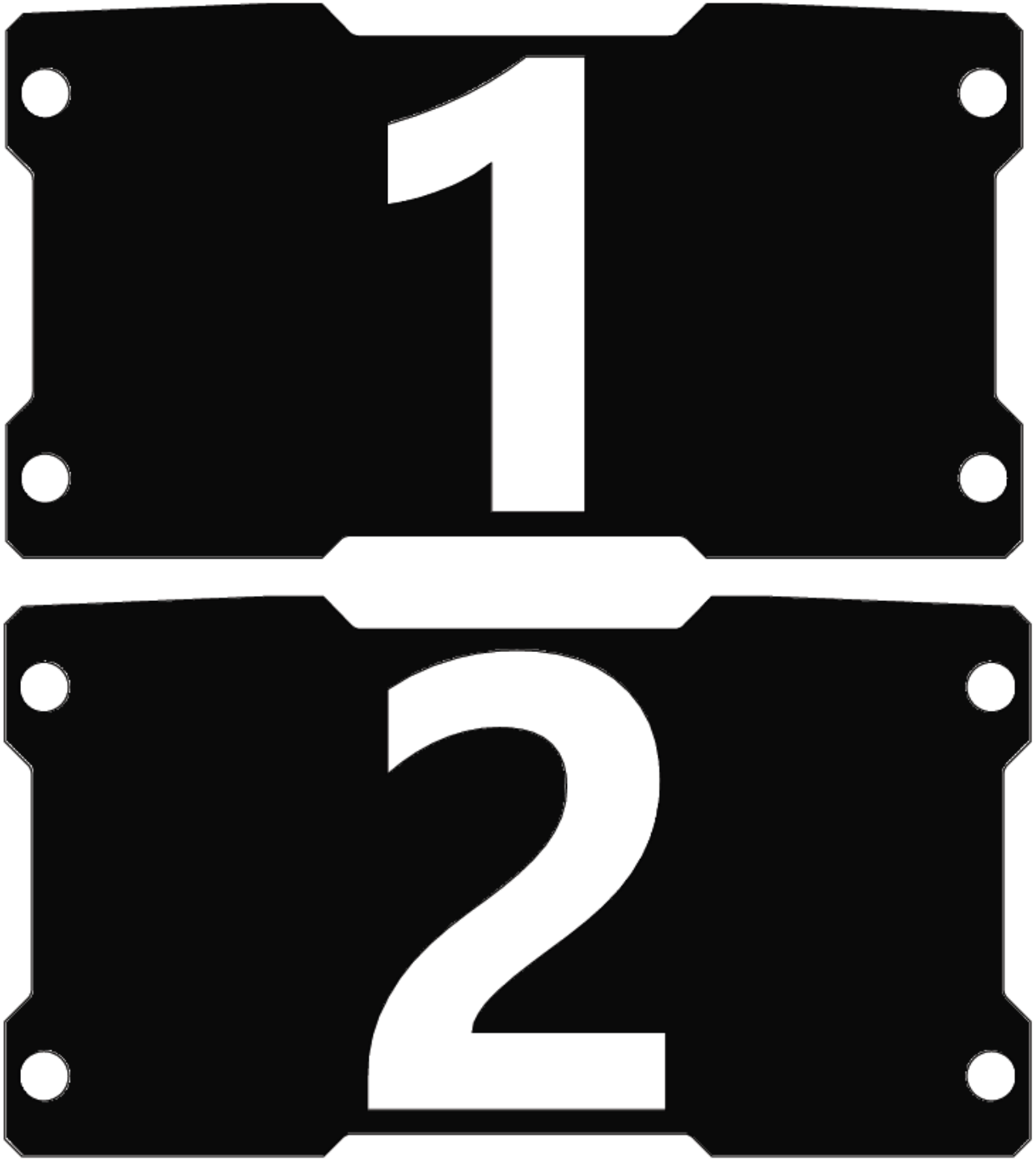

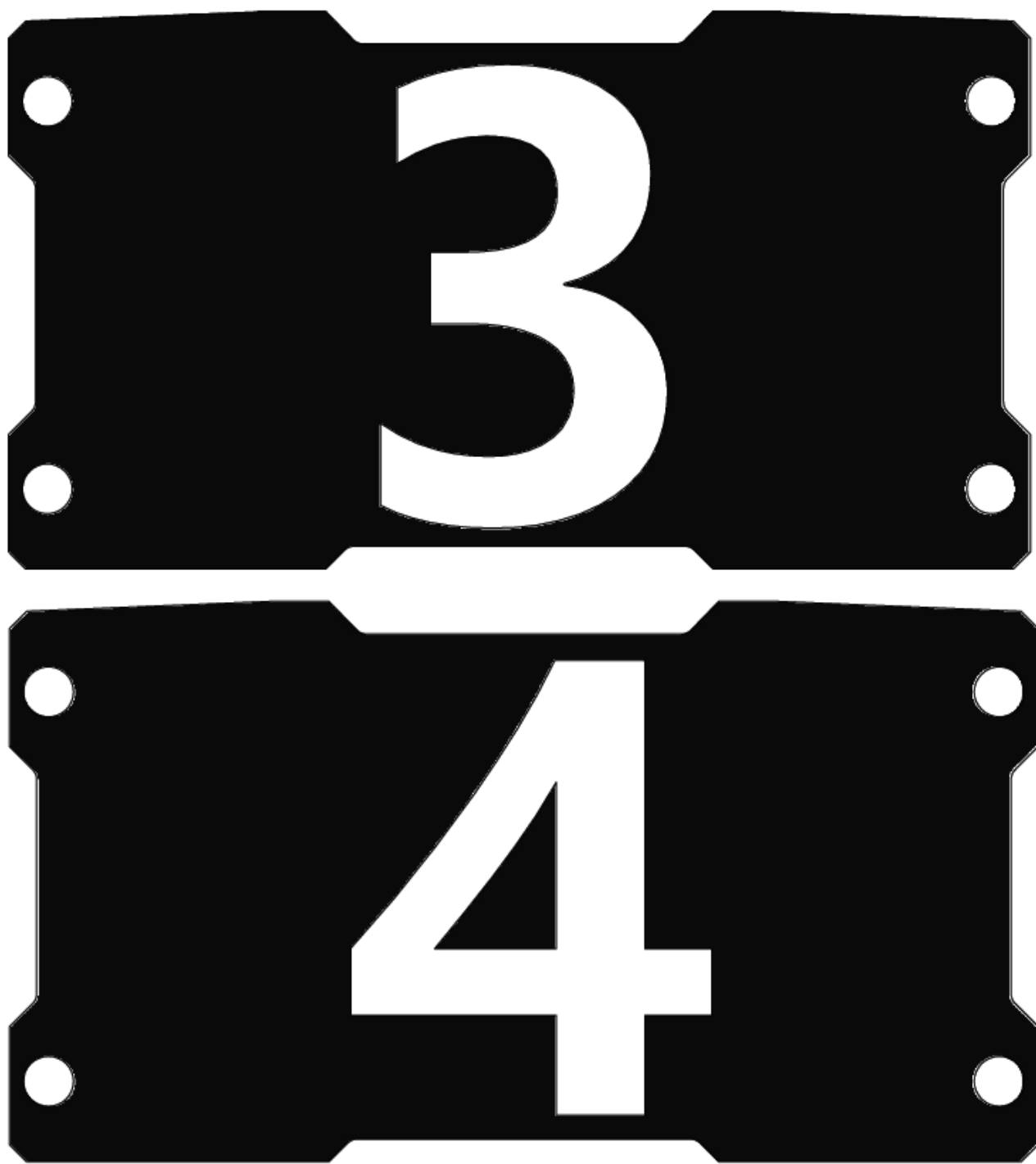









**E-mail:** [robomaster@dji.com](mailto:robomaster@dji.com)

**Forum:** [bbs.robomaster.com](http://bbs.robomaster.com)

**Website:** [www.robomaster.com](http://www.robomaster.com)

**Tel:** +86 (0)755 36383255 (UTC+8, 10:00AM-7:00PM, Monday to Friday)

**Address:** Room 202, Floor 2, Integrated Circuit Design & Application Industrial Park, No. 1089,  
Chaguang Road, Xili County, Nanshan District, Shenzhen City, Guangdong Province, China